

THIS DRAWING IS UNPUBLISHED. RELEASED FOR PUBLICATION ,19 .
 © COPYRIGHT 19 BY AMP INCORPORATED. ALL RIGHTS RESERVED.

LOC	DIST	REVISIONS					
		P	LTR	DESCRIPTION	DATE	DWN	APVD
G	14		E	REDRAWN PER 0720-0377-94	100CT94	LO	ME

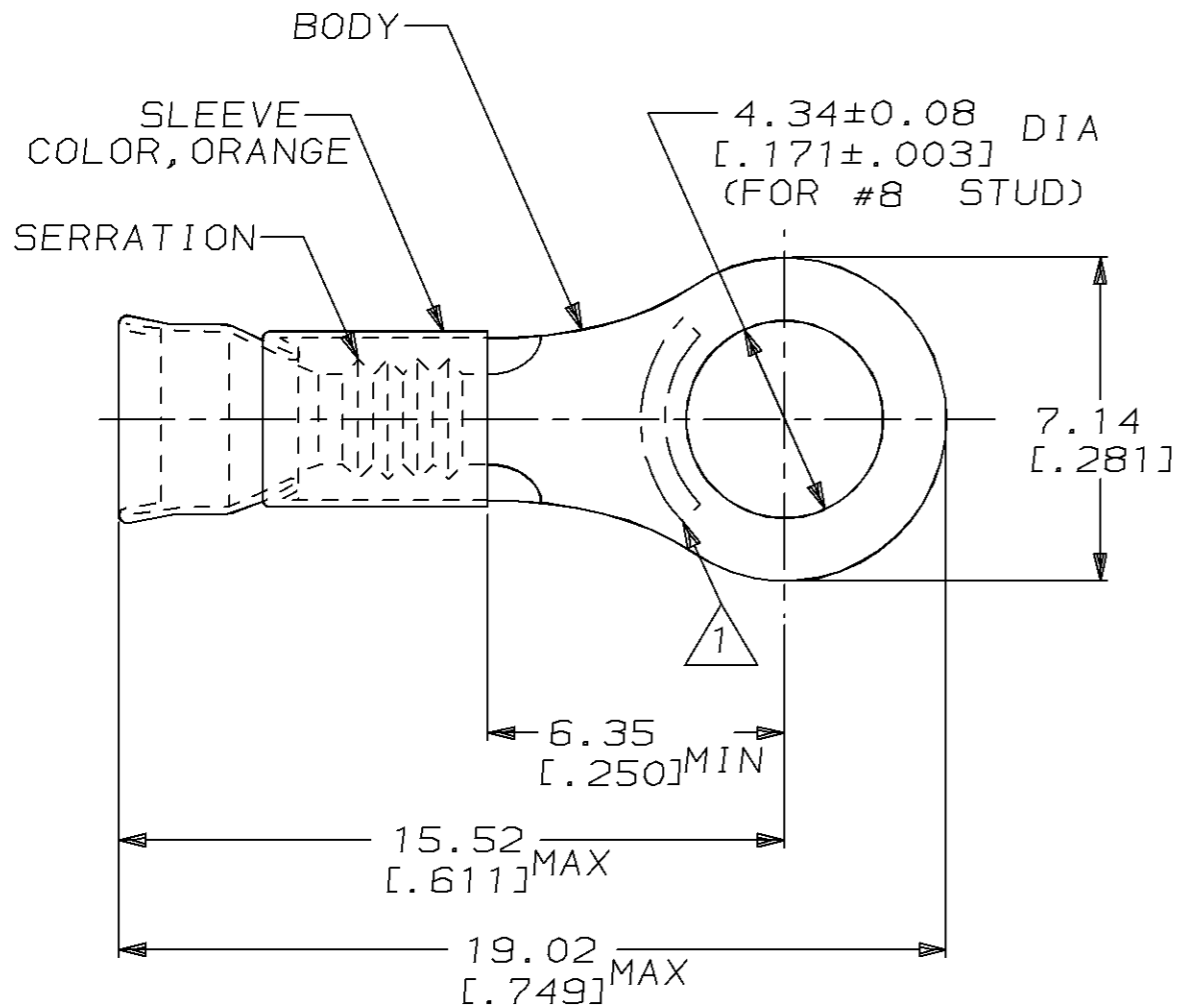

- 1. STAMP AMP 22-18 APPROX AS SHOWN
 22-16 TERMINALS ARE STAMPED 22-18 IN ACCORDANCE WITH MILITARY SPEC MIL-T-7928 COMMERCIAL WIRE RANGE IS 22-16
- 2. WIRE INSUL DIA, 2.67-3.56 [.105-.140]
- 3. TONGUE MATL THK, 0.79±0.05 [.031±.002]

1000	LOOSE PIECE	321893
QTY	PACKAGE TYPE	PART NO

AMP INCORPORATED CUSTOMER SERVICE SYSTEM		MAX RECOMMENDED OPERATING TEMPERATURE: 649°C [1200°F]	THIS DRAWING IS A CONTROLLED DOCUMENT FOR AMP INCORPORATED. IT IS SUBJECT TO CHANGE AND THE CONTROLLING ENGINEERING ORGANIZATION SHOULD BE CONTACTED FOR THE LATEST REVISION.		DWN L OLMEDA 100CT94	AMP Incorporated Harrisburg, PA 17105-3608
FOR ADDITIONAL PRODUCT INFORMATION OR COPIES OF DRAWINGS AND TECHNICAL DOCUMENTS	PRODUCT INFORMATION CENTER 1-800-522-6752		VOLTAGE RATING: -	DIMENSIONS: mm [in]	TOLERANCES UNLESS OTHERWISE SPECIFIED:	
FOR APPLICATION TOOLING INFORMATION	TOOLING ASSISTANCE CENTER 1-800-722-1111	CIRCULAR MIL AREA: 0.26mm²-1.65mm² [509-3260]		0 PLC ±-	APVD S BORTNER 100CT94	NAME TERMINAL, RING TONGUE, STRATOTHERM, DIAMOND GRIP, WIRE SIZE, 22-16 AWG
FOR ORDER ENTRY	1-800-526-5142	STRANDED WIRE		MATERIAL BODY, NI PER ASTM B162 SLEEVE, NI SIL PER ASTM B122	1 PLC ±- 2 PLC ±0.20 [.008] 3 PLC ±- 4 PLC ±- ANGLES ±-	PRODUCT SPEC -
					FINISH -	CAGE CODE 00779
					WEIGHT -	DRAWING NO C-321893
					CUSTOMER DRAWING	SCALE 6:1
						SHEET 1 OF 1
						REV E