

HOUSING

FIRST CIRCUIT INDICATOR

FCI PART NUMBER AND DATE CODE

HOLD DOWN SEE NOTES 8

SIGNAL CONTACT POWER CONTACTS

25Sx10P CONFIGURATION SHOWN
HOLD DOWN TYPE

SCREW MOUNT SEE NOTES 9



25Sx10P CONFIGURATION SHOWN
SCREW MOUNT TYPE

NOTES:

- HOUSING MATERIAL: GF LCP, COLOR: BLACK, UL 94 V-0 RATED
SIGNAL CONTACT MATERIAL: PHOSPHOR BRONZE
SIGNAL PIN OVERMOLD MATERIAL: GF POLYESTER
POWER CONTACT MATERIAL: COPPER ALLOY
- PLATING ON SIGNAL CONTACTS: 1.27µm MIN Ni UNDERPLATING ALL OVER WITH 0.76µm MIN GXT IN CONTACT MATING AREA, AND 0.5µm MIN MATTE TIN ON TAIL AREA.

PLATING ON POWER CONTACTS: 1.27µm MIN Ni UNDERPLATING ALL OVER WITH 0.76µm MIN GXT IN CONTACT MATING AREA, AND 0.5µm MIN MATTE TIN ON TAIL AREA.

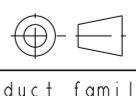
PLATING ON HOLD DOWN IF APPLICABLE: 1.27µm MIN Ni, UNDERPLATING ALL OVER WITH 0.76µm MIN MATTE TIN OVER.
- LUBRICATION: LUBRICATE ON CONTACT AREA.
- RECOMMENDED PCB THICKNESS IS:
FOR PRESS FIT APPLICATION: 1.4mm MIN
FOR SOLDER APPLICATION: 1.40mm THROUGH 2.62mm.
- FOR SCREW MOUNT APPLICATIONS, A #4-40 UNC PAN SCREW WITH HEX NUT IS RECOMMENDED (SUPPLIED BY CUSTOMER).
- FOR PRESS FIT $\varnothing 0.61 \pm 0.05\text{mm}$, FOR SOLDER $\varnothing 0.90 \pm 0.05\text{mm}$.
- UNPLATED HOLES.
- HOLD DOWN APPLICATION NEEDED.
- SCREW MOUNT APPLICATION NEEDED.
- PRODUCT SPECIFICATION: GS-12-1064
APPLICATION SPECIFICATION: GS-20-0362

spec ref	SEE NOTE 10	dr	Zhang Hong-Tu	2012/08/13	projection	MM	size	A2	scale	1:1	
tolerance std	TOLERANCES UNLESS OTHERWISE SPECIFIED	eng	De-Ming Lu	2017/05/09			ecn no	ELX-DG-18076-1			
ISO 406		chr	Fancy Zhang	2017/05/23			rel level	Released			
ISO 1101		appr	Pei-Ming Zheng	2017/05/26			product family	PwrLoPro			
surface	linear	0.X	±0.30		PWR LoPro HEADER ASSEMBLY		dwg no	10122460		rev	H
		0.XX	±0.20		RA, PASSIVE GUIDE,S+P						
		0.XXX	±0.10		cat. no.	-	Product - Customer Drw	sheet 1 of 10			
ISO 1302	angular	0°	±2°								

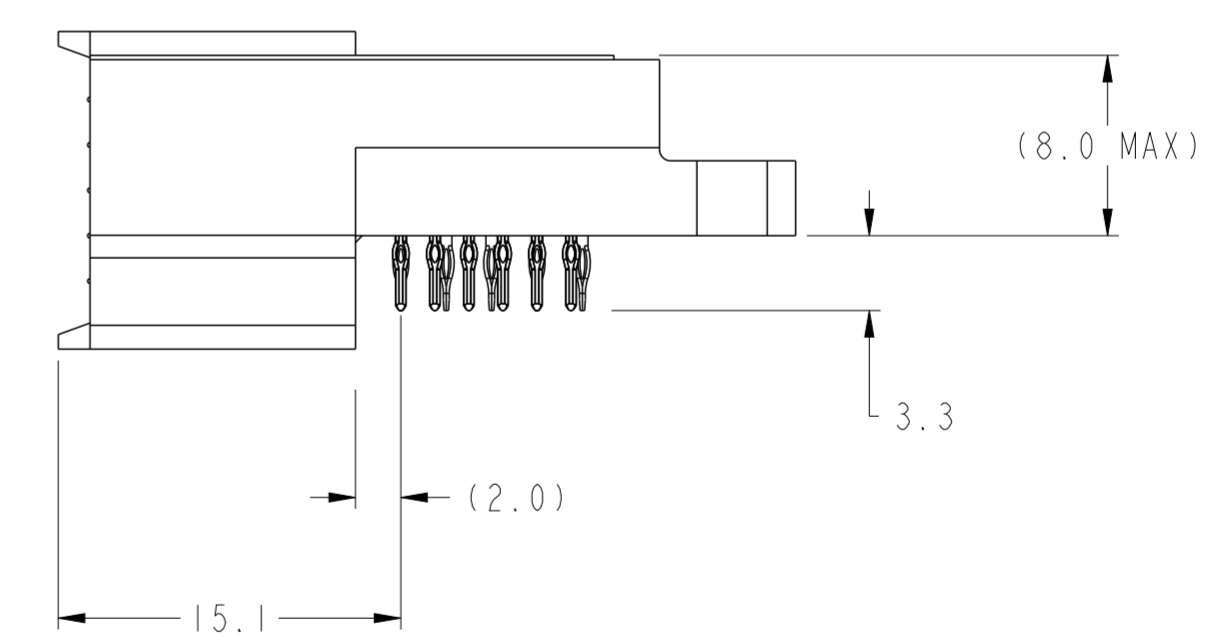
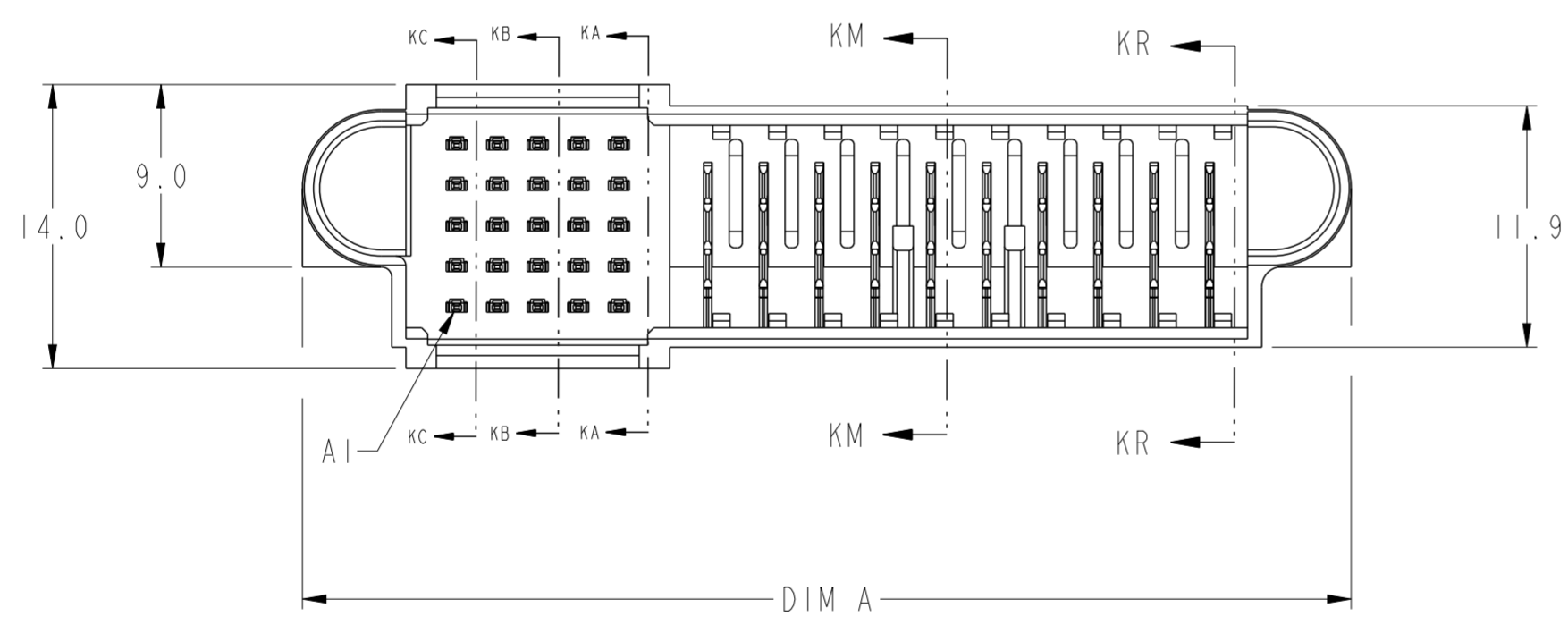
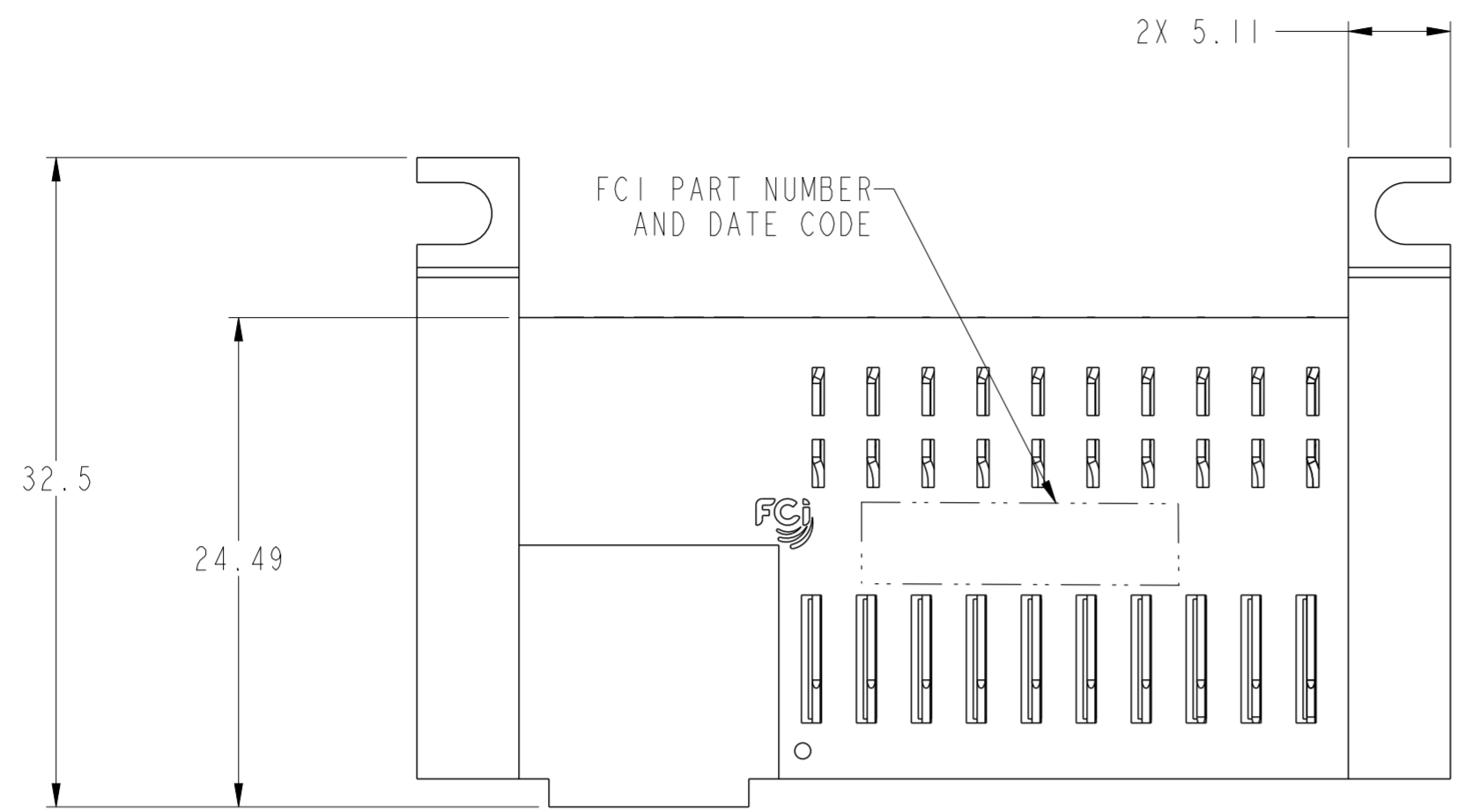

SCREW MOUNT TYPE AS SHOWN

spec ref	SEE NOTE 10	dr	Zhang Hong-Tu	2012/08/13	projection	MM	size	A2	scale	3:1
tolerance std	ISO 406 ISO 1101	eng	De-Ming Lu	2017/05/09			ecn no	ELX-DG-18076-1		
surface	TOLERANCES UNLESS OTHERWISE SPECIFIED linear 0.X ±0.30 0.XX ±0.20 0.XXX ±0.10 angular 0° ±2°	chr	Fancy Zhang	2017/05/23			rel level	Released		
		appr	Pei-Ming Zheng	2017/05/26			product family	PwrLoPro		
ISO 1302		Amphenol FCI	PWR LoPro HEADER ASSEMBLY		cat. no.	-	Product - Customer Drw	sheet 2 of 10	rev	H

PDS: Rev :H

STATUS:Released

Printed: May 26, 2017

Amphenol FCI

© 2016 AFCI

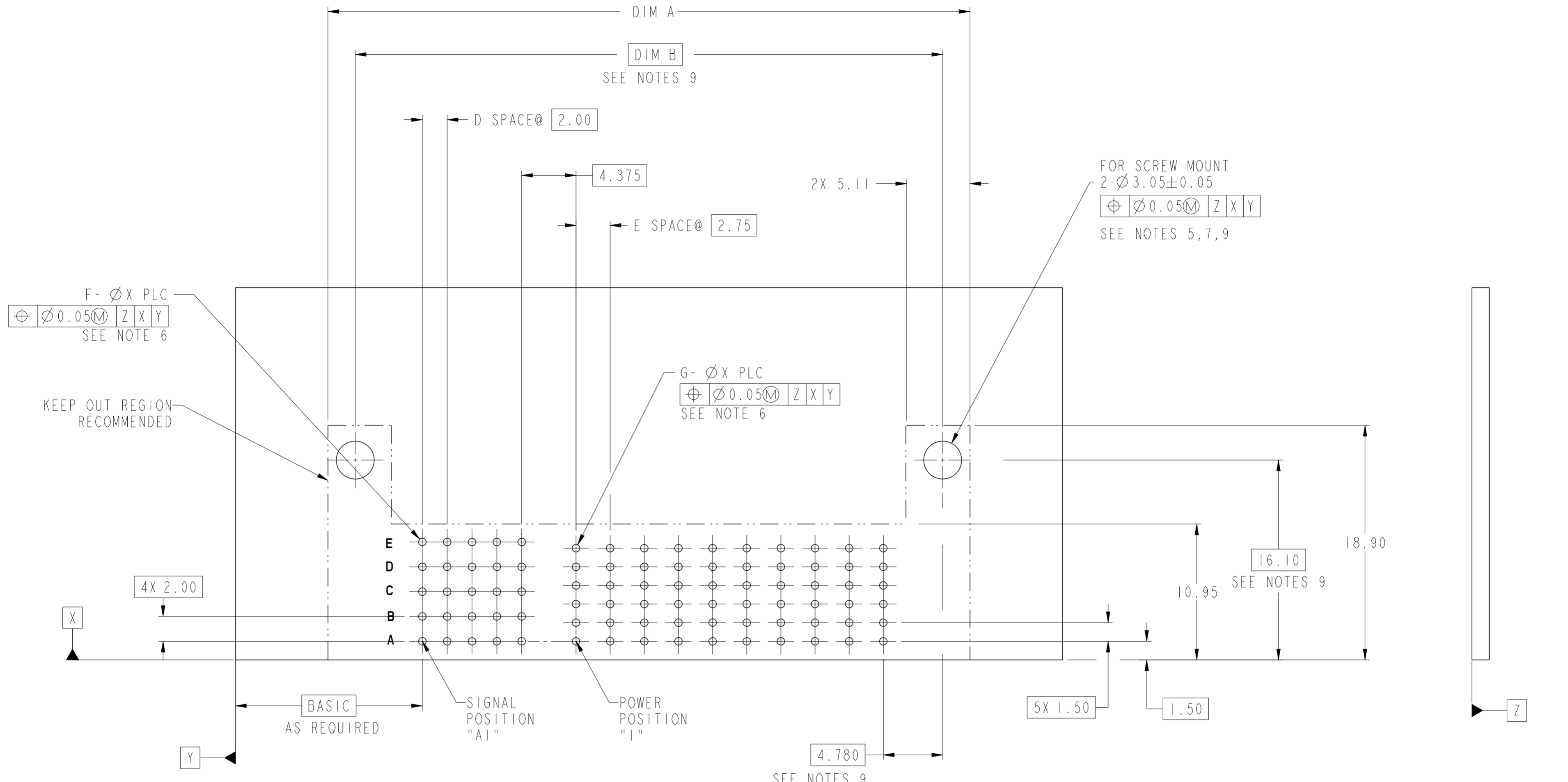

10122460-002LF AS SHOWN
 RECOMMENDED PRINTED CIRCUIT BOARD LAYOUT SEE NOTE 4
 FOR 10122460-XXXLF SCREW MOUNT TYPE
 (AS VIEWED FROM COMPONENT SIDE)

spec ref	SEE NOTE 10	dr	Zhang Hong-Tu	2012/08/13	projection	MM	size	A2	scale	3:1	
tolerance std	ISO 406 ISO 1101	eng	De-Ming Lu	2017/05/09		MM	ecn no	ELX-DG-18076-1	rel level	Released	
TOLERANCES UNLESS OTHERWISE SPECIFIED		chr	Fancy Zhang	2017/05/23							
		appr	Pei-Ming Zheng	2017/05/26							
surface	linear	0.X	± 0.30		product family		PwrLoPro	title PWR LoPro HEADER ASSEMBLY RA, PASSIVE GUIDE,S+P	dwg no 10122460	rev H	
		0.XX	± 0.20		cat. no.		-				Product - Customer Drw
	angular	0°	$\pm 2^\circ$		sheet 3 of 10						

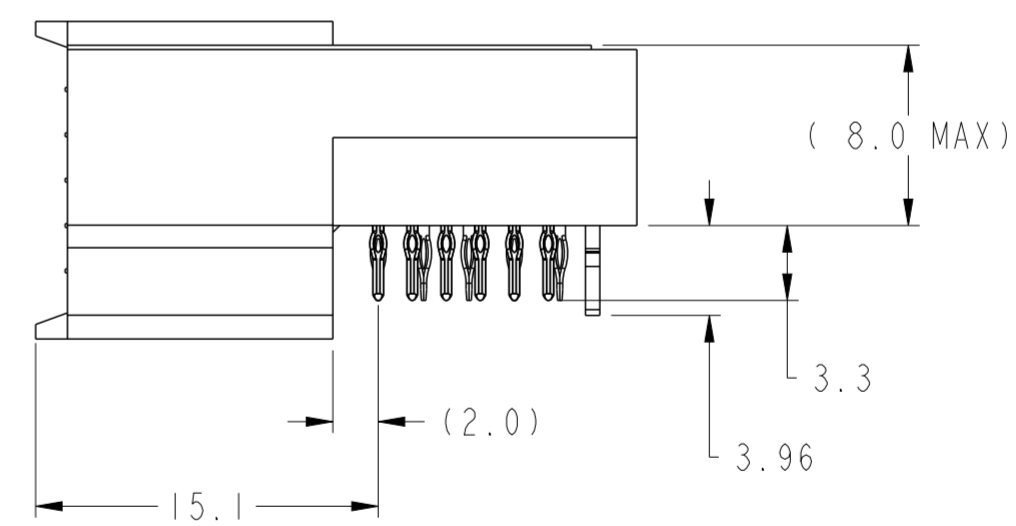
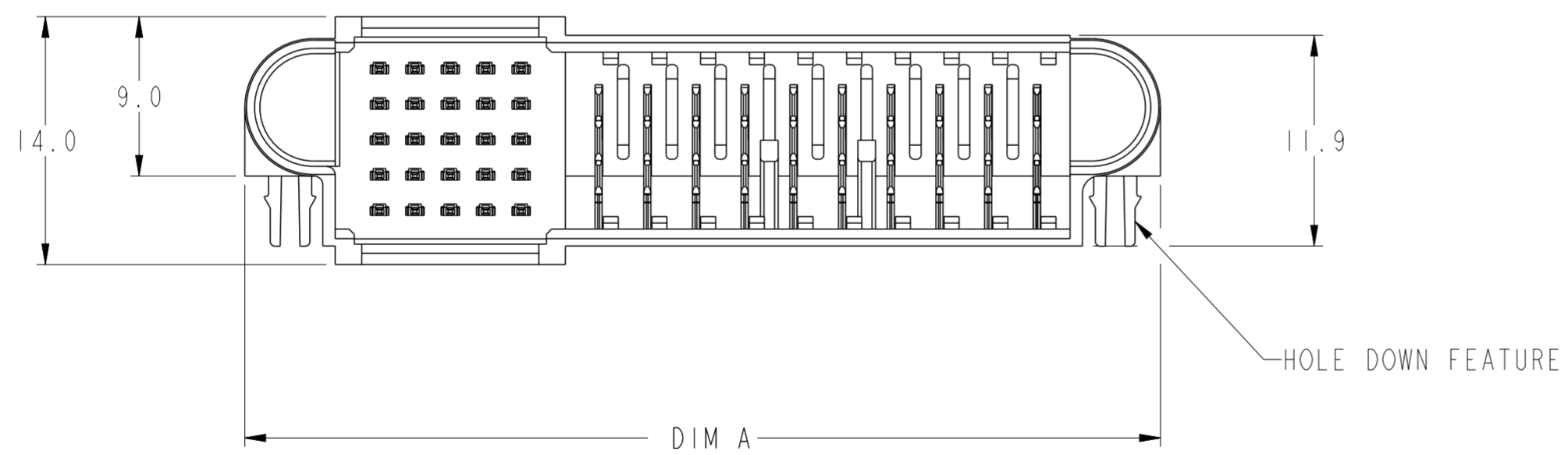
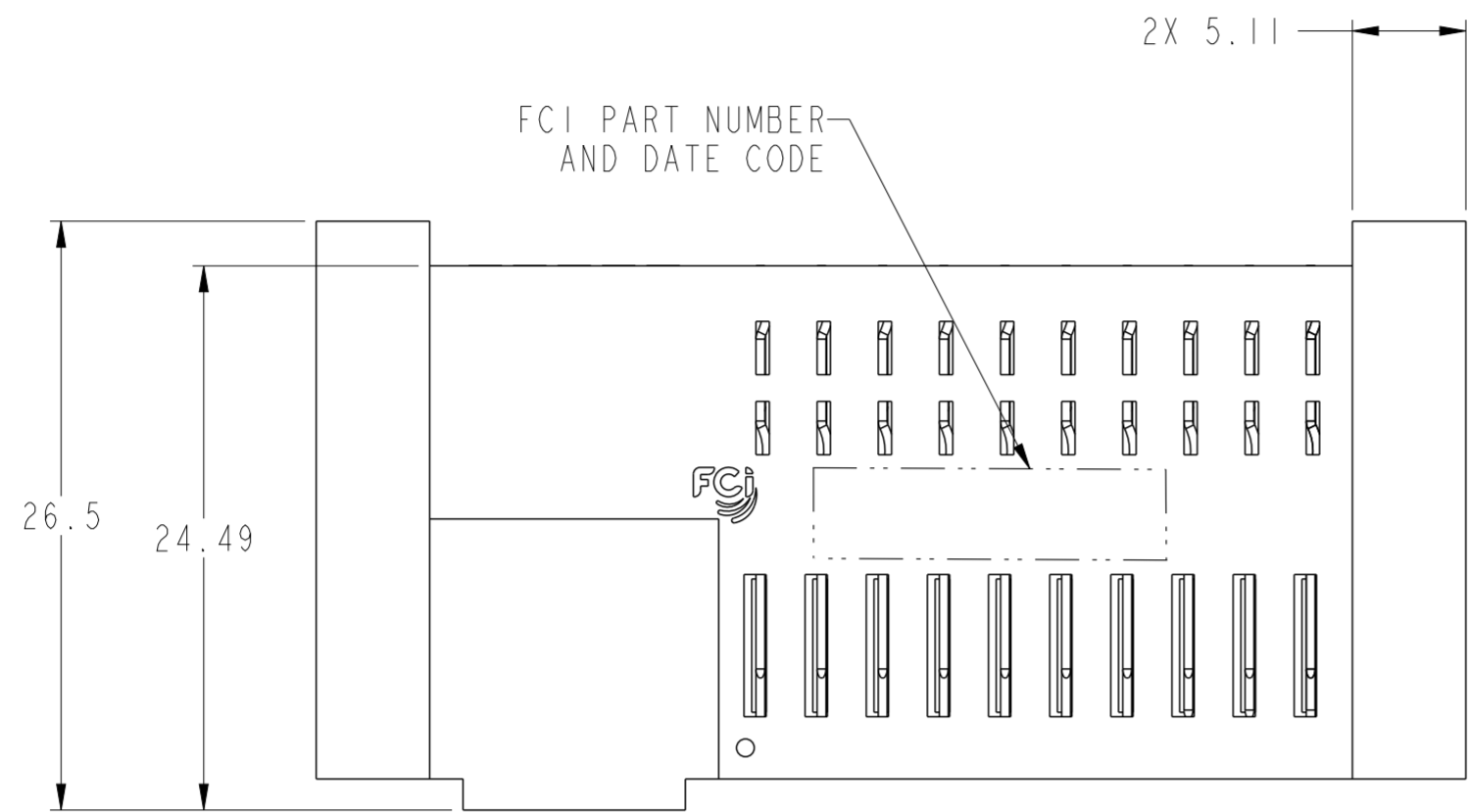

HOLE DOWN TYPE AS SHOWN

spec ref	SEE NOTE 10	dr	Zhang Hong-Tu	2012/08/13	projection	MM	size	A2	scale	3:1										
tolerance std	TOLERANCES UNLESS OTHERWISE SPECIFIED	eng	De-Ming Lu	2017/05/09			ecn no	ELX-DG-18076-1	rel level	Released										
ISO 406 ISO 1101		chr	Fancy Zhang	2017/05/23																
surface	<table border="1"> <tr> <td>linear</td> <td>0.X</td> <td>±0.30</td> </tr> <tr> <td></td> <td>0.XX</td> <td>±0.20</td> </tr> <tr> <td></td> <td>0.XXX</td> <td>±0.10</td> </tr> <tr> <td>angular</td> <td>0°</td> <td>±2°</td> </tr> </table>	linear	0.X	±0.30		0.XX	±0.20		0.XXX	±0.10	angular	0°	±2°	app	Pei-Ming Zheng	2017/05/26	product family	PwrLoPro	rel level	Released
linear		0.X	±0.30																	
		0.XX	±0.20																	
	0.XXX	±0.10																		
angular	0°	±2°																		
ISO 1302	Amphenol FCi	title	PWR LoPro HEADER ASSEMBLY		dwg no	10122460	rev	H												
		cat. no.			Product - Customer Drw	sheet 4 of 10														

PDS: Rev :H

STATUS:Released

Printed: May 26, 2017

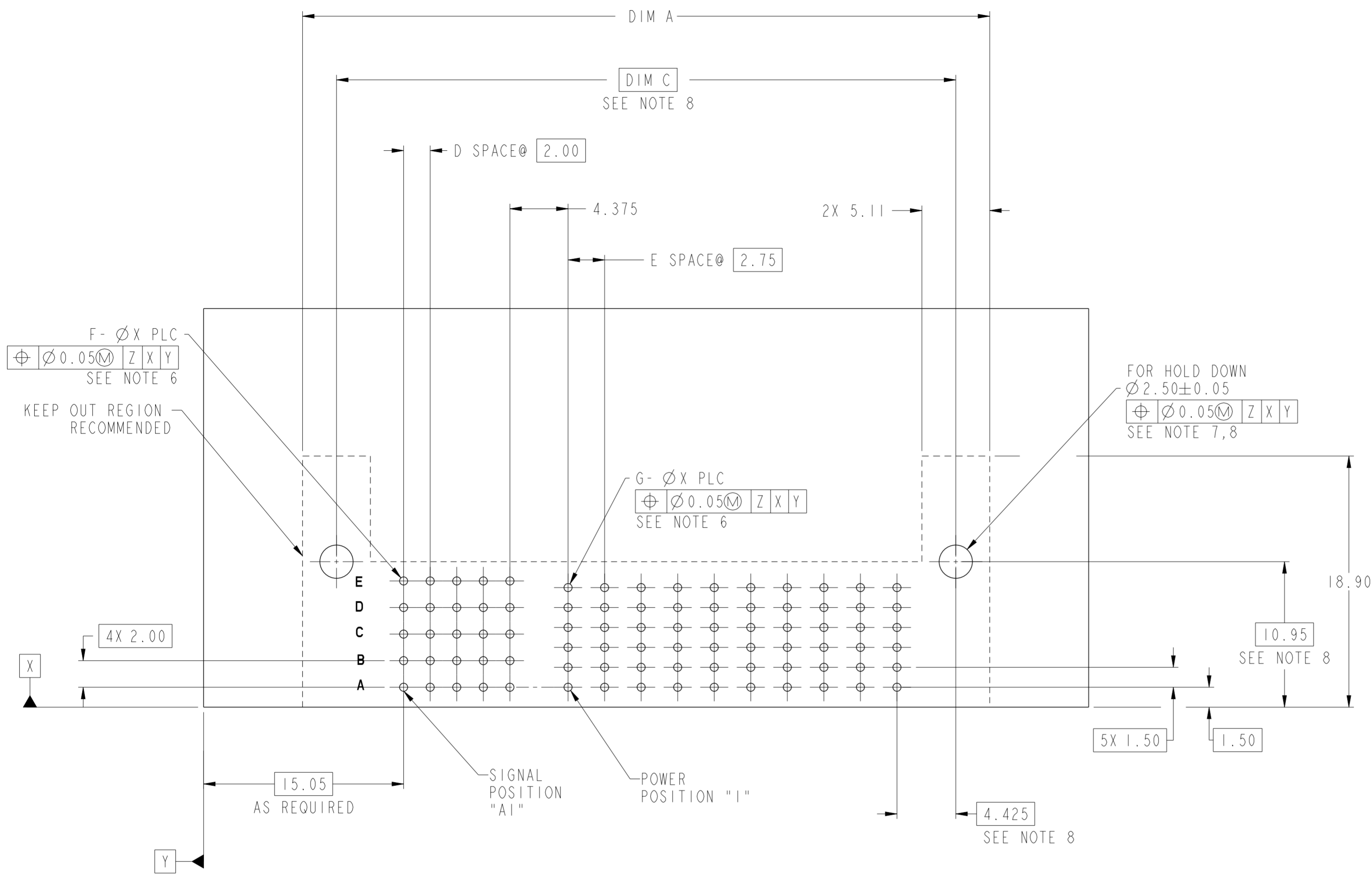

10122460-003LF AS SHOWN
 RECOMMENDED PRINTED CIRCUIT BOARD LAYOUT SEE NOTE 4
 FOR 10122460-XXXLF HOLD DOWN TYPE
 (AS VIEWED FROM COMPONENT SIDE)

spec ref	SEE NOTE 10	dr	Zhang Hong-Tu	2012/08/13	projection	MM	size	A2	scale	4:1	
tolerance std	ISO 406 ISO 1101	eng	De-Ming Lu	2017/05/09		MM	ecn no	ELX-DG-18076-1	rel level	Released	
TOLERANCES UNLESS OTHERWISE SPECIFIED		chr	Fancy Zhang	2017/05/23							
		appr	Pei-Ming Zheng	2017/05/26							
surface	ISO 1302	linear	0.X	±0.30	product family	PwrLoPro	rel level	Released	cat. no.	-	
			0.XX	±0.20	title	PWR LoPro HEADER ASSEMBLY		div no	10122460	rev	H
		angular	0°	±2°	RA, PASSIVE GUIDE,S+P		Product - Customer Drw	sheet 5 of 10			

PART NUMBER	CONFIGURATION	DIM "A"	DIM "B" FOR SCREW MOUNT	DIM "C" FOR HOLD DOWN	"D" SPACES	"E" SPACES	"F" QTY.	"G" QTY.	MOUNTING FEATURE
10122460-001LF	35S+18P	77.71	-	72.60	6	17	35	108	HOLD DOWN
10122460-003LF	25S+10P	51.71	-	46.6	4	9	25	60	HOLD DOWN
10122460-004LF	25S+8P	46.21	-	41.1	4	7	25	48	HOLD DOWN
10122460-005LF	25S+10P	51.71	-	46.6	4	9	25	60	HOLD DOWN
10122460-006LF	25S+8P	46.21	-	41.1	4	7	25	48	HOLD DOWN
10122460-007LF	25S+10P	51.71	47.31	-	4	9	25	60	SCREW MOUNT
10122460-008LF	15S+2P	25.71	-	15.1	2	1	15	12	HOLD DOWN
10122460-009LF	25S+10P	51.71	-	46.6	4	9	25	60	HOLD DOWN
10122460-010LF	35S+20P	83.21	-	78.1	6	19	35	120	HOLD DOWN
10122460-011LF	25S+02P	29.71	-	24.6	4	1	25	12	HOLD DOWN
10122460-013LF	25S+10P	51.71	47.31	-	4	9	25	60	SCREW MOUNT

Amphenol FCI

© 2016 AFCI

spec ref	SEE NOTE 10	dr	Zhang Hong-Tu	2012/08/13	projection	MM	size	A2	scale	3:1			
tolerance std	TOLERANCES UNLESS OTHERWISE SPECIFIED	eng	De-Ming Lu	2017/05/09		← MM →	ecn no	ELX-DG-18076-1					
ISO 406		chr	Fancy Zhang	2017/05/23			rel level	Released					
ISO 1101		appr	Pai-Ming Zheng	2017/05/26			product family	PwrLoPro					
surface	linear	0.X	±0.30	Amphenol FCI	PWR LoPro HEADER ASSEMBLY	RA, PASSIVE GUIDE,S+P	divg no	10122460	rev	H			
ISO 1302	0.XX	±0.20	cat. no.								-	Product - Customer Drw	sheet 6 of 10
	0.XXX	±0.10											
angular	0°	±2°											

CUSTOMER LOADING WORKSHEET FOR SIGNAL & POWER SEQUENCING LEVELS

PWR LO PRO - MATING FACE OF HEADER CONNECTOR(4)

E																																		
D																																		
C																																		
B																																		
A																																		
ROWS	MOUNTING FEATURE(3)	1	2	3	4	5	6	7	8	1	2	3	4	5	6	7	8	9	10	11	12	13	14	15	16	17	18	19	20	21	22	23	24	MOUNTING FEATURE(3)
		SIGNAL CONTACTS(2)								POWER CONTACTS(1)																								

- 1). LOAD WITH CHOICE OF 2 POWER CONTACT MATING LEVELS, SEE SECTIONS KM & KR FOR AVAILABLE LEVEL OPTIONS.
- 2). LOAD WITH CHOICE OF 3 SIGNAL CONTACT MATING LEVELS, SEE SECTIONS KA,KB,&KC FOR AVAILABLE LEVEL OPTIONS.
- 3). MOUNTING FEATURE OPTION "X"
 - H : HOLD DOWN TYPE
 - S : SCREW MOUNT TYPE
- 4). CUSTOMER LOADING WORKSHEET SHOWN AT MAXMUM SIZE CONFIGURATION (40Sx24P), SIGNALS AVAILABLE IN 2,3,4 THRU 8 POSITIONS, POWERS AVAILABLE IN 4,6,8 THRU 24 POSITIONS IN EVEN QUANTITIES ONLY.

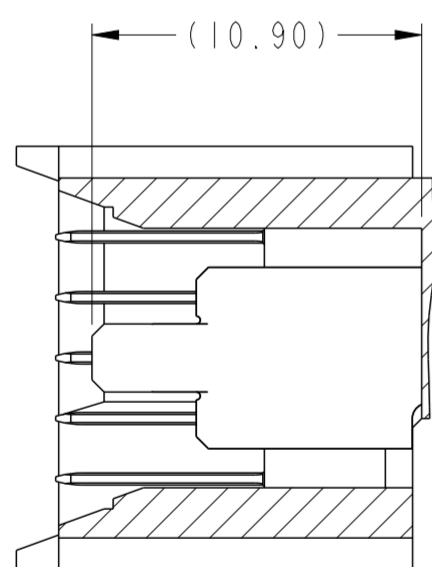

POWER SECTION KM-KM
LEVEL 1:
LONGEST MATING CONTACTS

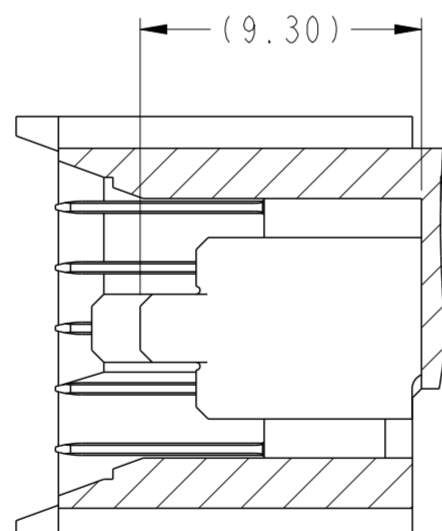

POWER SECTION KR-KR
LEVEL 2:
SHORTEST MATING CONTACTS

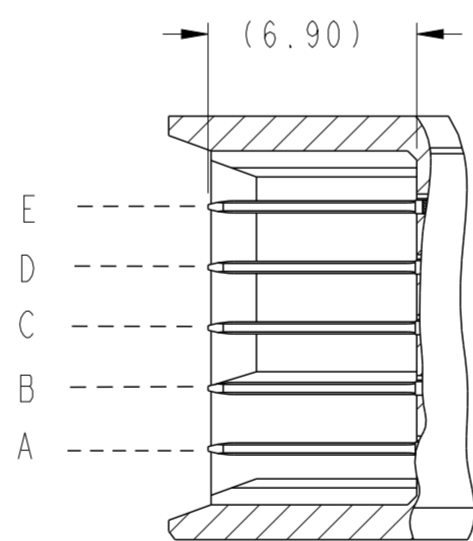

SIGNAL SECTION KA-KA
LEVEL 2:
ALL LONGEST CONTACTS

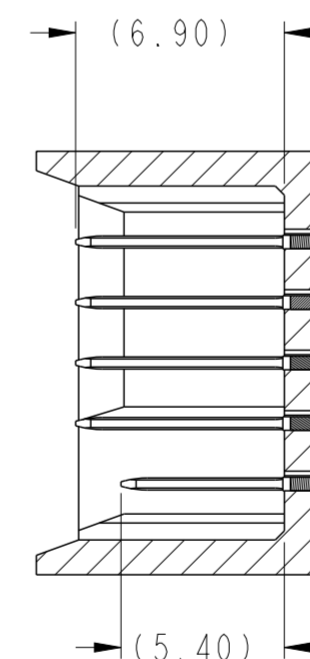

SIGNAL SECTION KB-KB
LEVEL 3222 (MIXED):
ROW "A", SHORTEST CONTACT
ROW "B" THRU "E", LONGEST CONTACTS

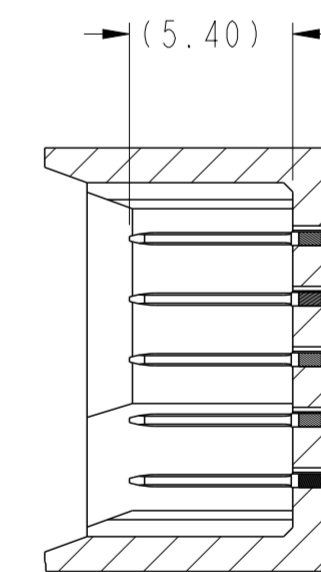

SIGNAL SECTION KC-KC
LEVEL 3:
ALL SHORTEST CONTACTS

Amphenol FCI

© 2016 AFCI

spec ref	SEE NOTE 10	dr	Zhang Hong-Tu	2012/08/13	projection	MM	size	A2	scale	1:1				
tolerance std	ISO 406 ISO 1101	eng	De-Ming Lu	2017/05/09			ecn no	ELX-DG-18076-1	rel level	Released				
surface	linear	0.X	±0.30	Amphenol FCI							PWR LoPro HEADER ASSEMBLY RA, PASSIVE GUIDE,S+P	cat. no.	Product - Customer Drw	sheet 7 of 10
		0.XX	±0.20											
		0.XXX	±0.10											
		angular	0°	±2°										

PDS: Rev :H

STATUS:Released

Printed: May 26, 2017

PART NUMBER	ROWS	SIGNALS							POWERS															
		1	2	3	4	5	6	7	1	2	3	4	5	6	7	8	9	10	11	12	13	14	15	16
10122460-001LF 35S + 18P	E																							
	D																							
	C																							
	B																							
	A																							

PART NUMBER	ROWS	SIGNALS					POWERS											
		1	2	3	4	5	1	2	3	4	5	6	7	8	9	10		
10122460-003LF 25S + 10P	E																	
	D																	
	C																	
	B																	
	A																	

PART NUMBER	ROWS	SIGNALS					POWERS									
		1	2	3	4	5	1	2	3	4	5	6	7	8		
10122460-004LF 25S + 8P	E															
	D															
	C															
	B															
	A															

PART NUMBER	ROWS	SIGNALS					POWERS											
		1	2	3	4	5	1	2	3	4	5	6	7	8	9	10		
10122460-005LF 25S + 10P	E																	
	D																	
	C																	
	B																	
	A																	

VIEWED FROM MATING FACE:

spec ref	SEE NOTE 10	dr	Zhang Hong-Tu	2012/08/13	projection	MM	size	A2	scale	1:1	
tolerance std	TOLERANCES UNLESS OTHERWISE SPECIFIED	eng	De-Ming Lu	2017/05/09			ecn no	ELX-DG-18076-1	rel level	Released	
ISO 406		chr	Fancy Zhang	2017/05/23							
ISO 1101		appr	Pai-Ming Zheng	2017/05/26							
surface	linear	0.X	±0.30		Amphenol FCI	PWR LoPro HEADER ASSEMBLY RA, PASSIVE GUIDE,S+P	dwg no 10122460	rev H	cat. no.	Product - Customer Drw	sheet 8 of 10
ISO 1302	angular	0°	±2°								

Amphenol FCI

© 2016 AFCI

PART NUMBER	ROWS	SIGNALS					POWERS									
		1	2	3	4	5	1	2	3	4	5	6	7	8		
10122460-006LF 25S + 8P	E	H	2	2	32222	2	2	-	-	2	2	2	2	2	-	H
	D															
	C															
	B															
	A															

PART NUMBER	ROWS	SIGNALS					POWERS											
		1	2	3	4	5	1	2	3	4	5	6	7	8	9	10		
10122460-007LF 25S + 10P	E	S	2	2	2	2	3	2	2	2	2	2	2	2	2	2	2	S
	D																	
	C																	
	B																	
	A																	

PART NUMBER	ROWS	SIGNALS			POWERS			
		1	2	3	1	2		
10122460-008LF 15S + 2P	E	H	32222	2	2	-	2	H
	D							
	C							
	B							
	A							

PART NUMBER	ROWS	SIGNALS					POWERS											
		1	2	3	4	5	1	2	3	4	5	6	7	8	9	10		
10122460-009LF 25S + 10P	E	H	2	2	3	2	2	2	2	2	2	2	2	2	2	2	2	H
	D																	
	C																	
	B																	
	A																	

Amphenol
FCi

© 2016 AFci

spec ref	SEE NOTE 10	dr	Zhang Hong-Tu	2012/08/13	projection	MM	size	A2	scale	1:1
tolerance std	TOLERANCES UNLESS OTHERWISE SPECIFIED	eng	De-Ming Lu	2017/05/09		Product family	PwrLoPro	ecn no	ELX-DG-18076-1	
ISO 406		chr	Fancy Zhang	2017/05/23				rel level	Released	
ISO 1101		appr	Pei-Ming Zheng	2017/05/26				rel level	Released	
surface	<input checked="" type="checkbox"/> linear <input type="checkbox"/> angular	Amphenol FCI			title PWR LoPro HEADER ASSEMBLY RA, PASSIVE GUIDE,S+P			dwg no 10122460	rev H	
ISO 1302		linear	0.X	±0.30	cat. no.	-	Product - Customer	Drw	sheet 9 of 10	
		linear	0.XX	±0.20						
	angular	0°	±2°							

PART NUMBER	ROWS	SIGNALS							POWERS																			
		1	2	3	4	5	6	7	1	2	3	4	5	6	7	8	9	10	11	12	13	14	15	16	17	18	19	20
10122460-010LF 35S + 20P	E																											
	D																											
	C	3	3	3	3	3	3	3	2	2	2	-	-	-	-	-	-	-	-	2	2	2	2	2	2	2	2	
	B																											
	A																											

PART NUMBER	ROWS	SIGNALS					POWERS	
		1	2	3	4	5	1	2
10122460-011LF 25S + 02P	E							
	D							
	C	2	32222	2	32222	2	1	2
	B							
	A							

PART NUMBER	ROWS	SIGNALS					POWERS										
		1	2	3	4	5	1	2	3	4	5	6	7	8	9	10	
10122460-013LF 25S + 10P	E																
	D																
	C	2	2	2	2	3	2	2	2	2	2	2	2	2	2	2	
	B																
	A																

CODE	DESCRIPTION
1	FOR LEVEL 1
2	FOR LEVEL 2
32222	FOR LEVEL 32222 (MIXED)
3	FOR LEVEL 3

Amphenol FCI

© 2016 AFCI

spec ref	SEE NOTE 10	dr	Zhang Hong-Tu	2012/08/13	projection	MM	size	A2	scale	1:1	
tolerance std	TOLERANCES UNLESS OTHERWISE SPECIFIED	eng	De-Ming Lu	2017/05/09		Product family	PwrLoPro	rel level	Released	ecn no	ELX-DG-18076-1
ISO 406		chr	Fancy Zhang	2017/05/23							
ISO 1101		appr	Pai-Ming Zheng	2017/05/26							
surface	linear	0.X	±0.30	Amphenol FCI	title	PWR LoPro HEADER ASSEMBLY	dwg no	10122460	rev	H	
ISO 1302	0.XX	±0.20									
	0.XXX	±0.10									
angular	0°	±2°	cat. no.	-	Product - Customer Drw	sheet 10 of 10					

PDS: Rev :H

STATUS:Released

Printed: May 26, 2017