

OA109 Series - All Metal

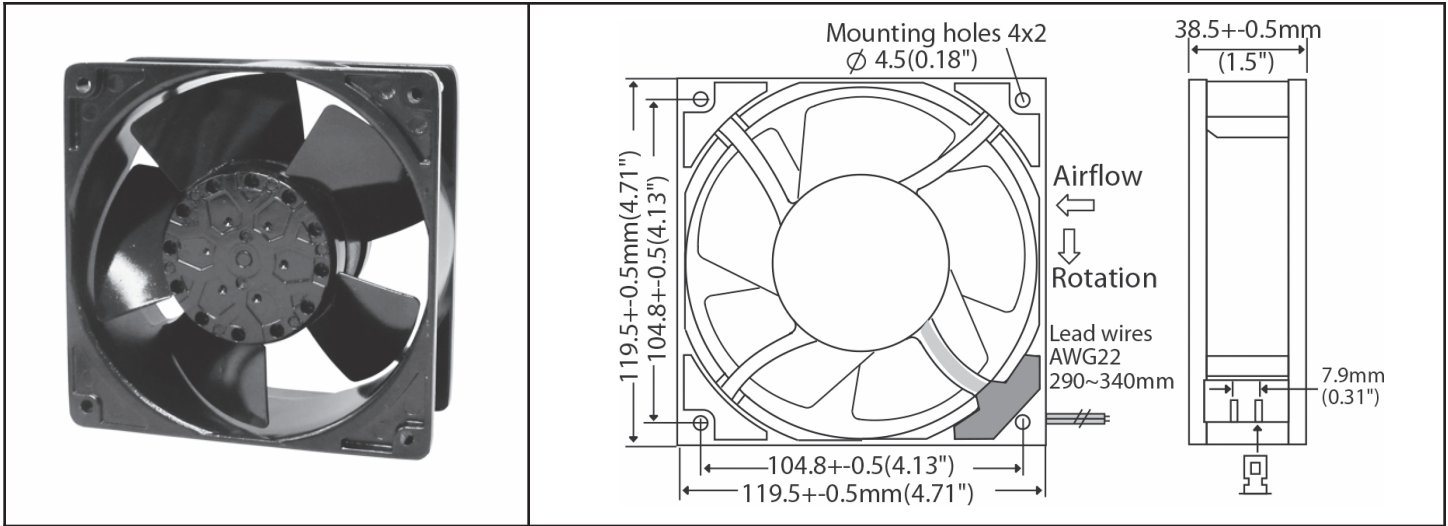

AC Fan - 115V, 230V
120x38mm (4.7"x 1.5")



Frame	Diecast Aluminum	Operating Temperature Ball Bearing -30C ~ +80C (non-condensing) Storage Temp -40C ~ +100C Life Expectancy Ball Bearing 50,000 hours (L10 at 55C) Environmental Protection IP55 Weight: ~ 1.3 lbs m0	
Impeller	Metal Alloy		
Connection	2x Lead Wires 22 AWG or terminals		
Motor	Shaded pole, impedance protected		
Bearing System	Dual ball bearing		
Insulation Resistance	>100M ohm between lead-wire and frame (500VDC)		
Dielectric Strength	1 min at 1500 VAC, 50/60Hz		

Model Number	Speed (RPM)	Airflow (CFM)	Noise (dB)	Volts AC	Voltage Range	Watts	Max. Static Pressure ("H ₂ O)	Curves
OA109AP-11-1 * 1855	2650 3100	90 105	48	115	100~120	21 10	0.25 0.22	2 (50Hz) 1 (60Hz)
OA109AP-11-2 * 1855	2400 2500	82 85	43	115	100~120	14 13	0.17 0.12	4 (50Hz) 3 (60Hz)
OA109AP-11-3 * 1855	1700 1800	58 60	32	115	100~120	12 9	0.11 0.09	6 (50Hz) 5 (60Hz)
OA109AP-22-1 * 1855	2650 3100	90 105	48	230	200~240	21 10	0.25 0.22	2 (50Hz) 1 (60Hz)
OA109AP-22-2 * 1855	2400 2500	82 85	43	230	200~240	14 13	0.17 0.12	4 (50Hz) 3 (60Hz)
OA109AP-22-3 * 1855	1700 1800	58 60	32	230	200~240	12 9	0.11 0.09	6 (50Hz) 5 (60Hz)

* Indicate "TB" for terminal type or "WB" for lead wires