



SIGN	DATE	DESCRIPTION	APPROVER
THIS IS CAD DRAWING, DO NOT REVISE MANUALLY!!!			

Material

- Terminal body
(metal housing): Brass(CuZn)
- Terminal screw: Steel Zinc plating "-" slot type
- Wire guard: PhBz Tin plated
- Insulator (housing): Thermoplastic (UL94V-0)

Electrical cULus /VDE / TUV

- Voltage rating: 300V /300V /300V
- Current rating: 15A /17A / 15A
- Wire range: 2.5mm²/0.34-2.5mm²
Solid wire(AWG): 12-24
Stranded wire(AWG): 12-24
- Torque: 3.5Lb-In / 0.5N.m /0.4N.m
- Screw: M3
- Wire strip length: 6-7mm
- Withstanding Voltage: 1.6KV / 2.5KV /2.5KV
- Operating temperature: -30°C to +105°C
- Safety approval:   

RoHS Compliant

PART NUMBER:

OSTTSXX515A

No. of Poles	COLOR
02 2 Poles	0: Black
03 3 Poles	5: Green (Standard)
... ..	6: Blue
24 24 Poles	8: Grey

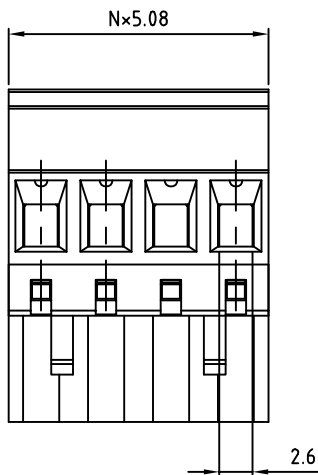
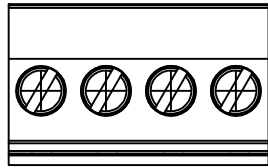

N = Number of poles

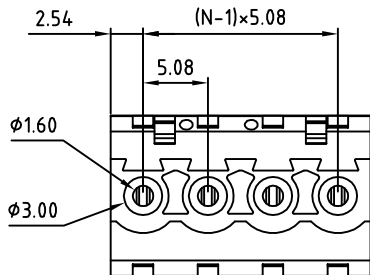
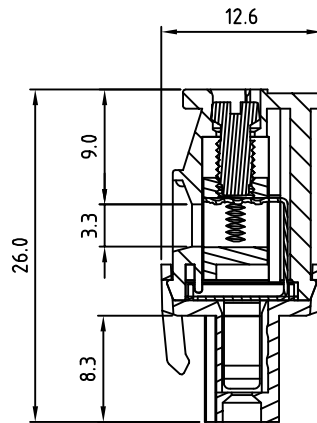

THESE DRAWINGS AND SPECIFICATIONS ARE THE PROPERTY OF ON-SHORE TECHNOLOGY, INC. AND SHALL NOT BE REPRODUCED, COPIED OR USED IN ANY MANNER WITHOUT THE PRIOR WRITTEN CONSENT OF ON-SHORE TECHNOLOGY, INC.



TITLE		OSTTS-5.08mm Series (w/latching hooks on the wire entry side)				
PART NO.	OSTTSXX515A	DWG NO.	OSTTSXX515A.DWG			
APPROVED	CHECKED	DESIGNED	DRAWN	CUST NO.	Tolerance	
Shi Jun 2006.10.25	Marvin 2005.10.25	Marvin 2005.10.25	Marvin 2005.10.25		UNIT: mm	X. ±0.50
				SHEET: 01/01	SCALE: NONE	X.X ±0.30
					REV: D	X.XX ±0.10
						X° ±1°