



## Comair Rotron Specification Sheet

Specification Date: April 19, 2017

RoHS Compliant

Version: 00

COMAIR ROTRON PART NUMBER: 17000657A  
COMAIR ROTRON MODEL NUMBER: CR2258-3600E1B

---

### A.) MOTOR:

RATED VOLTAGE:	115 VAC
START VOLTAGE:	87 VAC
OPERATING VOLTAGE RANGE:	103~126 VAC
OPERATING FREQUENCY:	50/60 Hz
MAX. RUNNING CURRENT:	1.13 Amps
INPUT POWER:	88 Watts
NOMINAL SPEED:	3600 RPM $\pm$ 10% (At Free Delivery)
MOTOR TYPE:	Brushless EC
MOTOR PROTECTION:	By Integrated Circuit
LOCKED ROTORT PROTECTION:	IC protected
POLARITY PROTECTION:	Yes
AUTOMATIC RESTART CAPABILITY:	By Integrated Circuit
ROTATION:	Clockwise when viewed from the impeller

### B.) MECHANICAL

DIMENSIONS:	225x225x80 mm <i>Figure 1</i>
WEIGHT:	1.83 Kg
BEARING TYPE:	Permanently Lubricated Ball Bearings
VENTURI:	High quality magnesium alloy die-casting frame with ED coating& powder coating.
PROPELLER:	High quality magnesium alloy die-casting frame with ED coating& powder coating.



# Comair Rotron Specification Sheet

Specification Date: April 19, 2017

RoHS Compliant

Version: 00

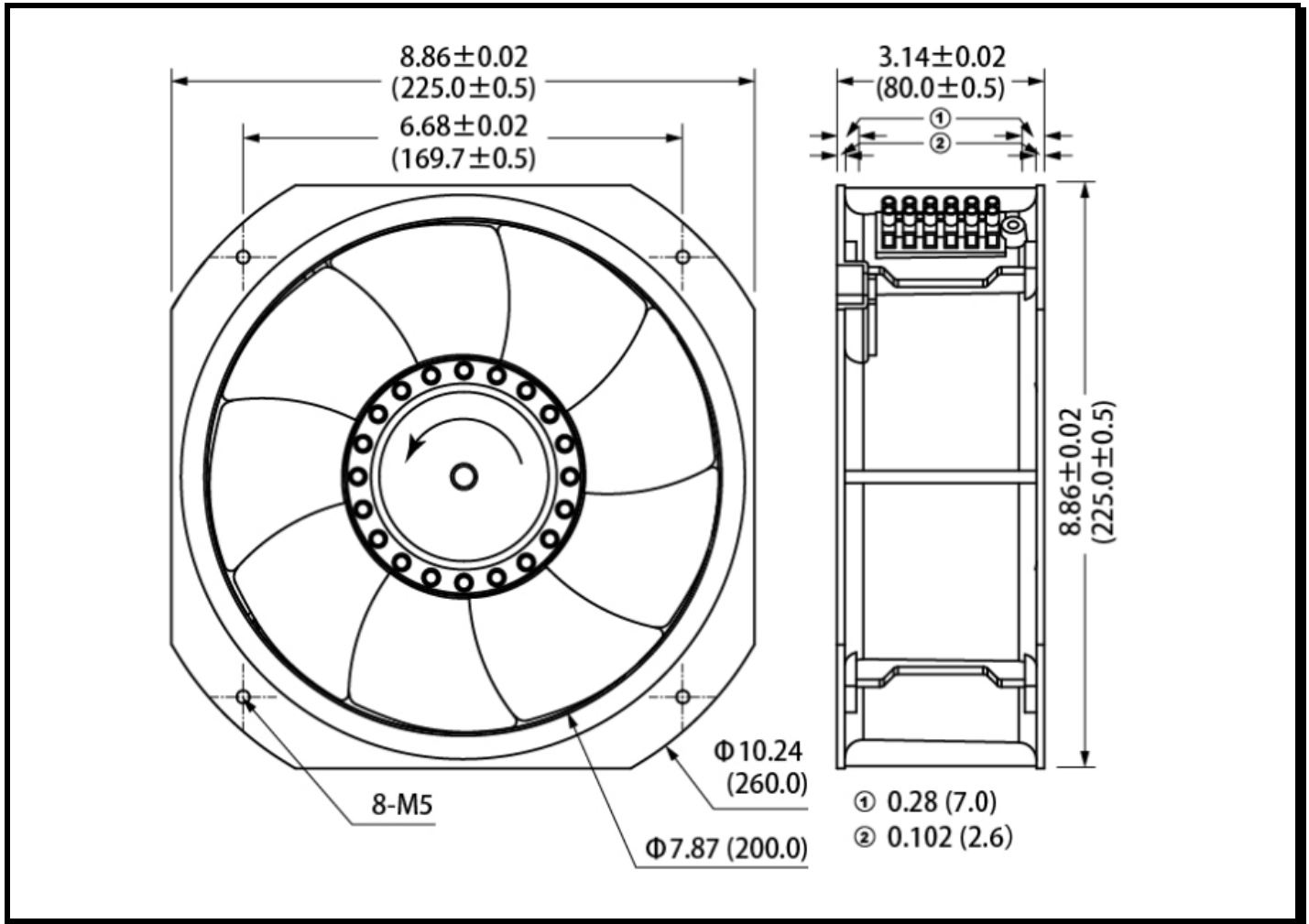

Figure 1

## C.) ENVIRONMENTAL

OPERATING TEMPERATURE:

-20°C to +70°C

STORAGE TEMPERATURE:

The storage temperature will be suggested at -20°C ~ 50°C to ensure a better performance.

HUMIDITY:

20 to 85% RH, non-condensing

## D.) PERFORMANCE CHARACTERISTICS

AIR FLOW:

754 CFM  $\pm$  5%, Curve C  
(At Free Delivery and MAX. speed)



# Comair Rotron Specification Sheet

Specification Date: April 19, 2017

RoHS Compliant

Version: 00

STATIC PRESSURE:

1.42" Inches of H<sub>2</sub>O, Curve C

(At Shut-Off and MAX. speed)

ACOUSTIC LEVEL:

71 dBA Max. at MAX. speed

(Measured via Freely Suspended at 1 meter )

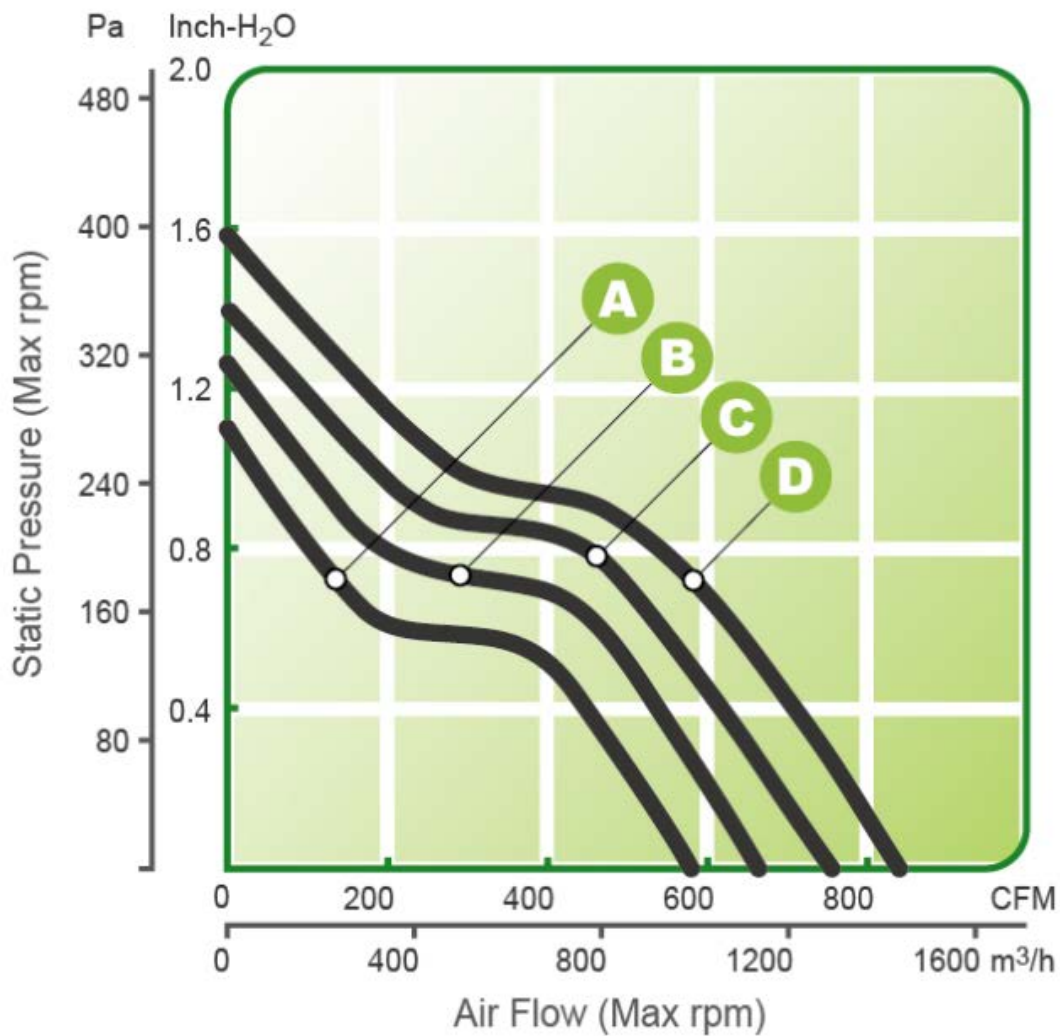



## Comair Rotron Specification Sheet

Specification Date: April 19, 2017

RoHS Compliant

Version: 00

### E.) TERMINATION

Suit with terminal block, PV1.25-3A-0.5 terminal

### F.) RELIABILITY

Bearing type	Temperature	Hours
<b>Ball bearing</b>	20°C	60,000
	40°C	50,000
	60°C	40,000
	90°C	20,000

### G.) SAFETY

UL, CUL, TUV, CE