

Eleven press-fit (compliant) pins for single sided use in .062+ (1.57+mm) PCB's with tin plated through holes.

Dual side "belly-to-belly" use requires .093 (2.36 mm) minimum PCB thickness.

Material full-hard, tin plated brass or bronze .010 (0.25mm) thick.

EC NO: USY2003-0028 IDRW: KLOYD 2002/09/19 CHKD: BRUSSELL 2002/09/19 APPR: KLOYD 2002/10/01	QUALITY SYMBOLS ▽ = 0 ▽ = 0	GENERAL TOLERANCES (UNLESS SPECIFIED)		SCALE 3:1	DESIGN UNITS METRIC	THIRD ANGLE PROJECTION	REVISE ON CAD ONLY		
		4 PLACES ± --- ± ---	3 PLACES ± --- ± .002	DIMENSION STYLE IN/MM		TITLE SFP CAGE ASSEMBLY WITH 11 PRESS-FIT LEGS AND 3 EMI CLIPS			
		2 PLACES ± 0.05 ± ---	1 PLACE ± --- ± ---	DRAWN BY DIRKERS	DATE 2001/12/18	MOLEX INCORPORATED			
		ANGULAR ± 1/2°		CHECKED BY BRUSSELL	DATE 2001/12/18	APPROVED BY BRUSSELL	DATE 2001/12/18	MATERIAL NO 73927-0008	DOCUMENT NO SD-73927-008
DRAFT WHERE APPLICABLE MUST REMAIN WITHIN DIMENSIONS		THIS DRAWING CONTAINS INFORMATION THAT IS PROPRIETARY TO MOLEX INCORPORATED AND SHOULD NOT BE USED WITHOUT WRITTEN PERMISSION							

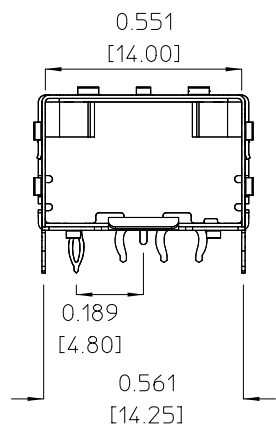

Cage Front View

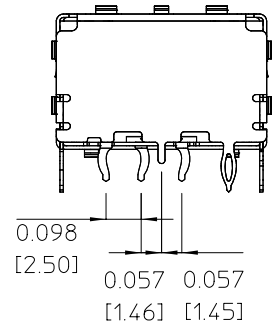

Center EMI Pins

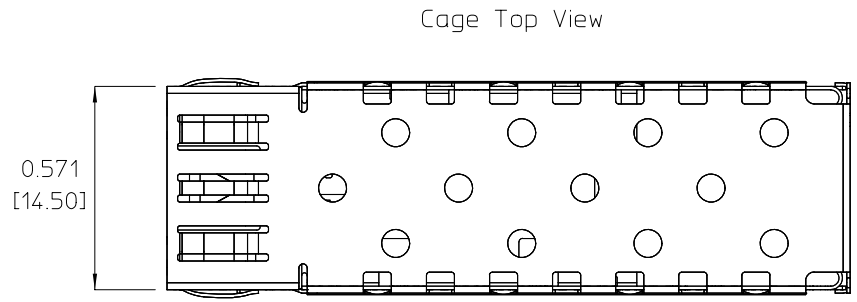

Cage Top View

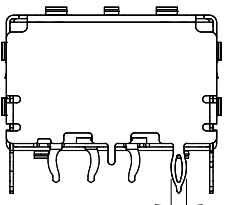
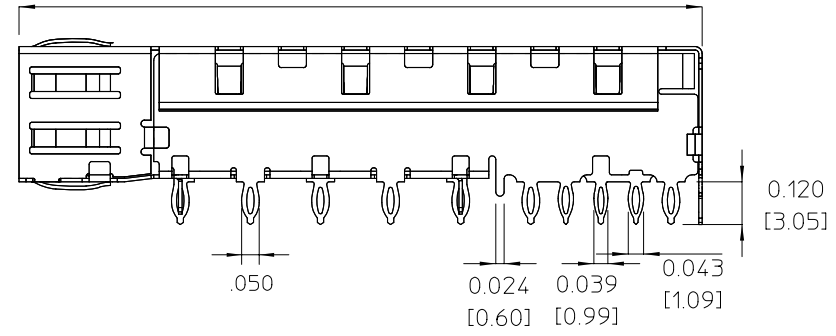

Cage Rear View

EC NO: <b>USY2002-0826</b> DRWN: KLOYD 2002/09/19 CHKD: BRUSSELL 2002/09/19 APPR: KLOYD 2002/10/01	QUALITY SYMBOLS ▽ = 0 ▽ = 0	GENERAL TOLERANCES (UNLESS SPECIFIED) <table border="1"> <thead> <tr> <th></th> <th>mm</th> <th>INCH</th> </tr> </thead> <tbody> <tr> <td>4 PLACES</td> <td>± .---</td> <td>± .---</td> </tr> <tr> <td>3 PLACES</td> <td>± .---</td> <td>± .002</td> </tr> <tr> <td>2 PLACES</td> <td>± 0.05</td> <td>± .---</td> </tr> <tr> <td>1 PLACE</td> <td>± .---</td> <td>± .---</td> </tr> </tbody> </table> ANGULAR ±1/2° DRAFT WHERE APPLICABLE MUST REMAIN WITHIN DIMENSIONS		mm	INCH	4 PLACES	± .---	± .---	3 PLACES	± .---	± .002	2 PLACES	± 0.05	± .---	1 PLACE	± .---	± .---	SCALE 3:1 DESIGN UNITS METRIC DIMENSION STYLE IN/MM DRAWN BY DIRKERS DATE 2001/12/18 CHECKED BY BRUSSELL DATE 2001/12/18 APPROVED BY BRUSSELL DATE 2001/12/18	THIRD ANGLE PROJECTION REVISE ON CAD ONLY TITLE SFP CAGE ASSEMBLY WITH 11 PRESS-FIT LEGS AND 3 EMI CLIPS MOLEX INCORPORATED MATERIAL NO 73927-0008 DOCUMENT NO SD-73927-008 SHEET NO 2 OF 7
		mm	INCH																
	4 PLACES	± .---	± .---																
	3 PLACES	± .---	± .002																
2 PLACES	± 0.05	± .---																	
1 PLACE	± .---	± .---																	
THIS DRAWING CONTAINS INFORMATION THAT IS PROPRIETARY TO MOLEX INCORPORATED AND SHOULD NOT BE USED WITHOUT WRITTEN PERMISSION	B																		

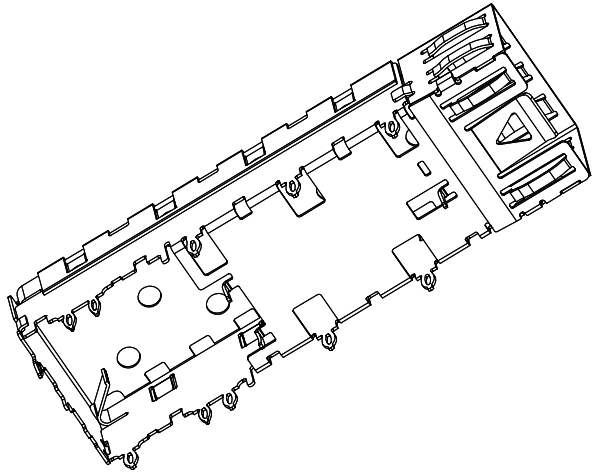

Isometric  
Scale 2.5:1

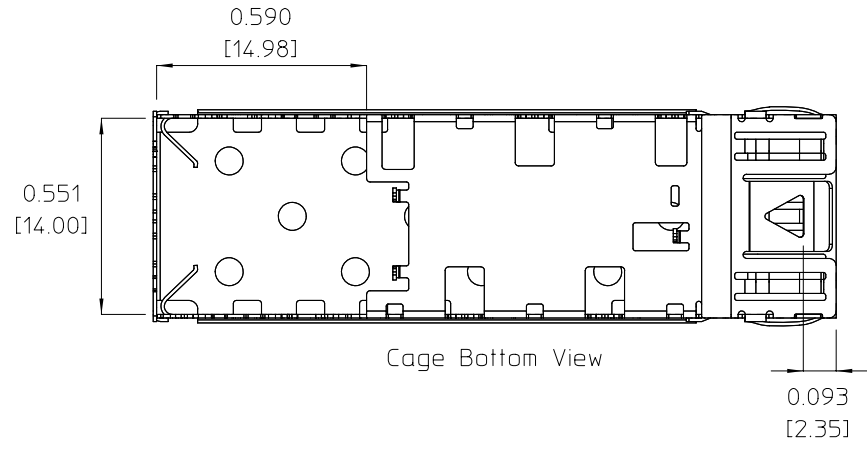
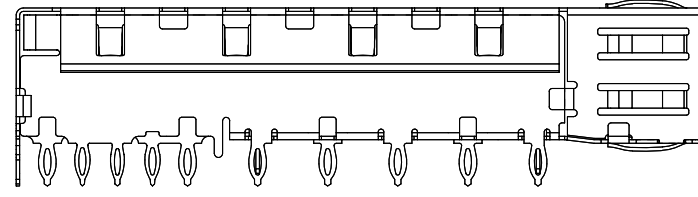

Cage Bottom View

EC NO: W51720027-00826 DRWN: KLOYD 2002/09/19 CHKD: BRUSSELL 2002/09/19 APPR: KLOYD 2002/10/01	QUALITY SYMBOLS ▽ = 0 ▽ = 0	GENERAL TOLERANCES (UNLESS SPECIFIED) 4 PLACES ± --- ± --- 3 PLACES ± --- ± .002 2 PLACES ± 0.05 ± --- 1 PLACE ± --- ± --- ANGULAR ± 1/2°	SCALE 3:1 DESIGN UNITS METRIC DIMENSION STYLE IN/MM DRAWN BY DIRKERS DATE 2001/12/18 CHECKED BY BRUSSELL DATE 2001/12/18 APPROVED BY BRUSSELL DATE 2001/12/18	THIRD ANGLE PROJECTION REVISE ON CAD ONLY	TITLE SFP CAGE ASSEMBLY WITH 11 PRESS-FIT LEGS AND 3 EMI CLIPS MOLEX INCORPORATED
	DRAFT WHERE APPLICABLE MUST REMAIN WITHIN DIMENSIONS	MATERIAL NO 73927-0008 DOCUMENT NO SD-73927-008 SHEET NO 3 OF 7			
	THIS DRAWING CONTAINS INFORMATION THAT IS PROPRIETARY TO MOLEX INCORPORATED AND SHOULD NOT BE USED WITHOUT WRITTEN PERMISSION				
	B				

Cross-hatched area denotes component and trace keep-out (except chassis ground)

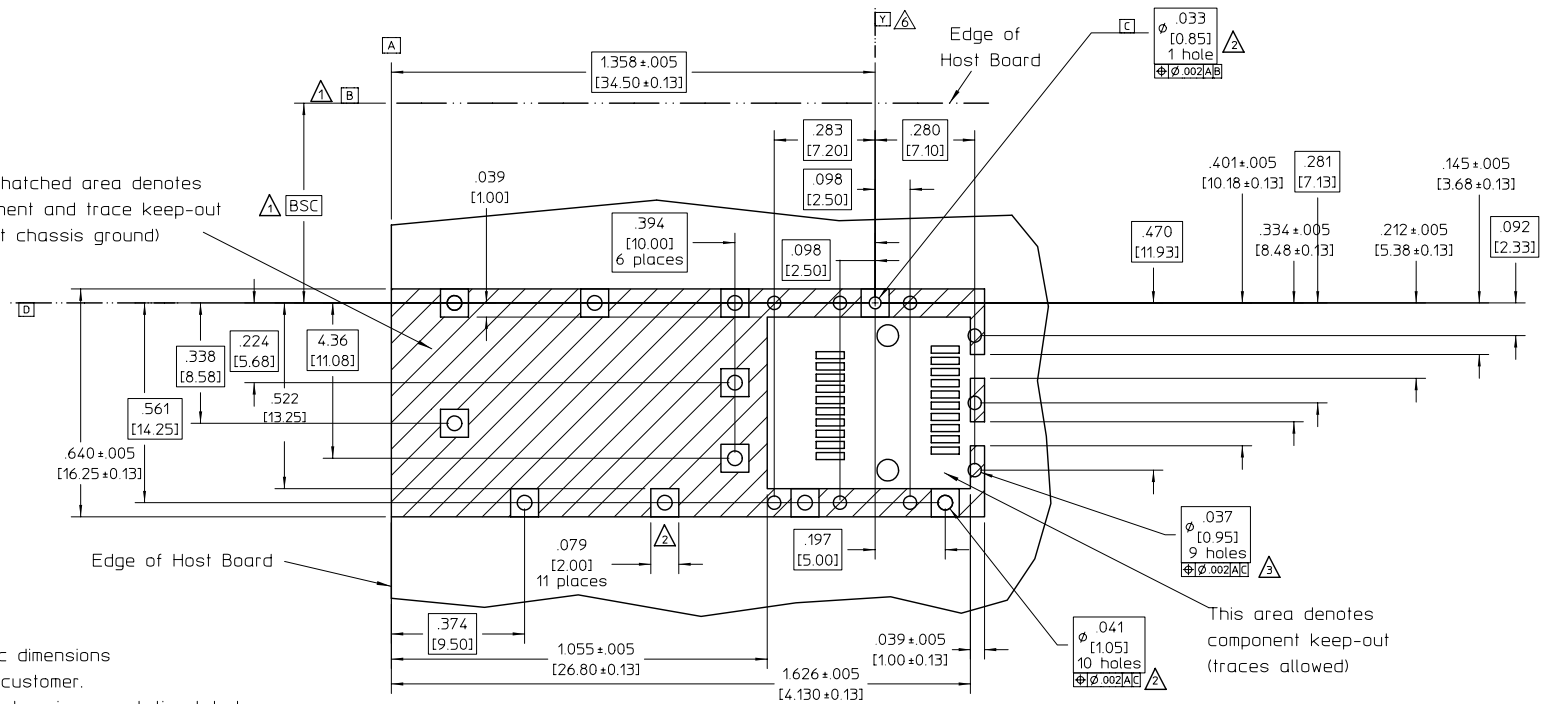

- ▲ Datum and basic dimensions established by customer.
- ▲ Vias and pads chassis ground, tin plated through, 11 places. Pads optional.
- ▲ Holes optionally plated through.
- 4 Hole pattern allows two parts to be mounted "belly-to-belly" on .093"+ nom. boards. Hole layout shown for one side only. Transceiver profile determines minimum board thickness in "belly-to-belly" applications.
- ▲ Cage datum Y shown for reference to cage, only.

This area denotes component keep-out (traces allowed)

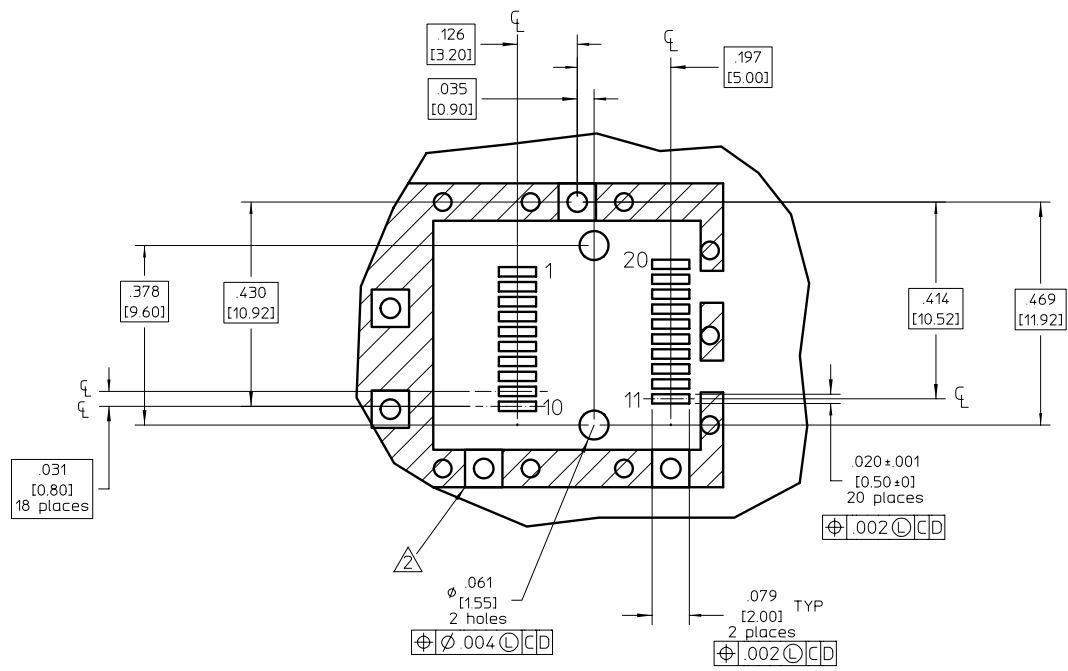

EC NO: <b>UST2002-0826</b> DRWN: KLOYD 2002/09/19 CHKD: BRUSSELL 2002/09/19 APPR: KLOYD 2002/10/01	QUALITY SYMBOLS ▼ = 0 ▽ = 0	GENERAL TOLERANCES (UNLESS SPECIFIED)		SCALE 3:1	DESIGN UNITS METRIC	THIRD ANGLE PROJECTION	REVISE ON CAD ONLY
		4 PLACES ± --- ± --- 3 PLACES ± --- ± .002 2 PLACES ± 0.05 ± --- 1 PLACE ± --- ± ---	DIMENSION STYLE IN/MM	TITLE SFP CAGE ASSEMBLY WITH 11 PRESS-FIT LEGS AND 3 EMI CLIPS			
		ANGULAR ± 1/2°	DRAWN BY DIRKERS DATE 2001/12/18	MOLEX INCORPORATED			
		DRAFT WHERE APPLICABLE MUST REMAIN WITHIN DIMENSIONS	CHECKED BY BRUSSELL DATE 2001/12/18	MATERIAL NO 73927-0008	DOCUMENT NO SD-73927-008		
SHEET NO 4 OF 7	THIS DRAWING CONTAINS INFORMATION THAT IS PROPRIETARY TO MOLEX INCORPORATED AND SHOULD NOT BE USED WITHOUT WRITTEN PERMISSION						



1. Connector pad pattern per MSA, will accommodate surface mount Molex connector 74441 or equivalent.  
 ⚠ Cage mounting pads not required for press-fit application.

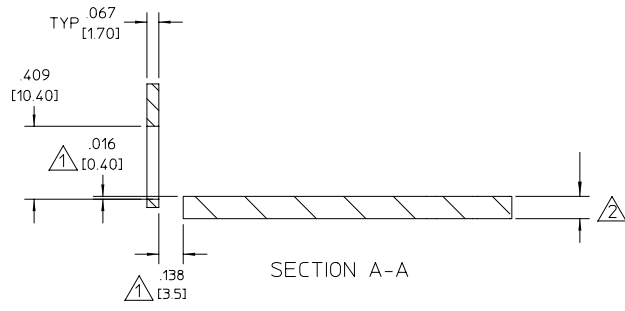
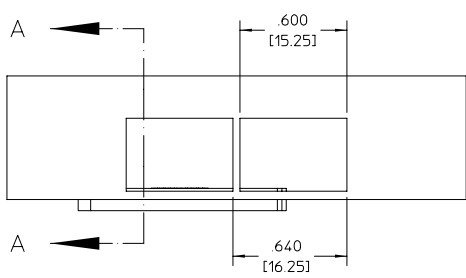
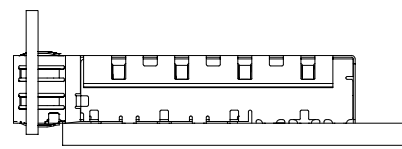
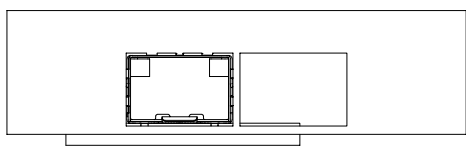



EC NO: <b>USY2002-0826</b> DRWN: KLOYD 2002/09/19 CHKD: BRUSSELL 2002/09/19 APPR: KLOYD 2002/10/01	QUALITY SYMBOLS	GENERAL TOLERANCES (UNLESS SPECIFIED)		SCALE 4:1	DESIGN UNITS METRIC	THIRD ANGLE PROJECTION	REVISE ON CAD ONLY
	▽ = 0	4 PLACES	± ---	± ---	DIMENSION STYLE IN/MM	TITLE SFP CAGE ASSEMBLY WITH 11 PRESS-FIT LEGS AND 3 EMI CLIPS	
	∇ = 0	3 PLACES	± ---	± .002			
		2 PLACES	± 0.05	± ---	DRAWN BY DIRKERS	DATE 2001/12/18	MATERIAL NO 73927-0008
	1 PLACE	± ---	± ---	CHECKED BY BRUSSELL	DATE 2001/12/18	SHEET NO 5 OF 7	
		ANGULAR ±1/2°		APPROVED BY BRUSSELL		DATE 2001/12/18	
		DRAFT WHERE APPLICABLE MUST REMAIN WITHIN DIMENSIONS		THIS DRAWING CONTAINS INFORMATION THAT IS PROPRIETARY TO MOLEX INCORPORATED AND SHOULD NOT BE USED WITHOUT WRITTEN PERMISSION			



 Relational geometry per MSA standard  
 See sheet 1 for PCB thickness details.

EC NO: <b>USY2002-0826</b> DRWN: KLOYD 2002/09/19 CHKD: BRUSSELL 2002/09/19 APPR: KLOYD 2002/10/01	DESCRIPTION REV	QUALITY SYMBOLS	GENERAL TOLERANCES (UNLESS SPECIFIED)	SCALE 1.5:1	DESIGN UNITS METRIC	 THIRD ANGLE PROJECTION	REVISE ON CAD ONLY
		▽ = 0 ▽ = 0	mm    INCH 4 PLACES ± --- ± --- 3 PLACES ± --- ± .002 2 PLACES ± 0.05 ± --- 1 PLACE ± --- ± --- ANGULAR ± 1/2°	DIMENSION STYLE IN/MM DRAWN BY DIRKERS    DATE 2001/12/18 CHECKED BY BRUSSELL    DATE 2001/12/18 APPROVED BY BRUSSELL    DATE 2001/12/18	TITLE SFP CAGE ASSEMBLY WITH 11 PRESS-FIT LEGS AND 3 EMI CLIPS MOLEX INCORPORATED	MATERIAL NO 73927-0008 DOCUMENT NO SD-73927-008 SHEET NO 6 OF 7	
DRAFT WHERE APPLICABLE MUST REMAIN WITHIN DIMENSIONS			THIS DRAWING CONTAINS INFORMATION THAT IS PROPRIETARY TO MOLEX INCORPORATED AND SHOULD NOT BE USED WITHOUT WRITTEN PERMISSION				

DATE	REV	CHANGES	REASONS	APPROVAL
2001/06/30	A	INITIAL DRAWING		CD
2002/01/31	B	SHEET 1,B9&C4&E2: TEXT CHANGE. SHEET 4,B9: TEXT CHANGE SHEET 6, B9: TEXT CHANGE, D3: NOTE ADDED	REMOVE 3 EMI PINS. REPLACE WITH COUNTERCUTS. CUSTOMER REQUEST.	CD
2002/09/19	C	SHEET 1,B9&C4&E2: TEXT CHANGE. SHEET 4,B9: TEXT CHANGE SHEET 6, B9: TEXT CHANGE, D3: NOTE ADDED	CORRECTION	KL

EC NO: USY2003-0028 DRWN: KLOYD 2002/09/19 CHK: BRUSSELL APPR: KLOYD 2002/10/01	QUALITY SYMBOLS  - 0  = 0	GENERAL TOLERANCES (UNLESS SPECIFIED)		SCALE 1:1	DESIGN UNITS METRIC	 THIRD ANGLE PROJECTION	REVISE ON CAD ONLY			
				DIMENSION STYLE IN/MM			TITLE			
		4 PLACES ± --- ± ---		3 PLACES ± --- ± .002		DRAWN BY DIRKERS	DATE 2001/12/18	SFP CAGE ASSEMBLY WITH 11 PRESS-FIT LEGS AND 3 EMI CLIPS		
		2 PLACES ± 0.05 ± ---		1 PLACE ± --- ± ---		CHECKED BY BRUSSELL	DATE 2001/12/18			
ANGULAR ± 1/2 °		DRAFT WHERE APPLICABLE MUST REMAIN WITHIN DIMENSIONS		APPROVED BY BRUSSELL	DATE 2001/12/18	 MOLEX INCORPORATED	MATERIAL NO. 739270008	DOCUMENT NO. SD-73927-008	SHEET NO. 7 OF 7	
THIS DRAWING CONTAINS INFORMATION THAT IS PROPRIETARY TO MOLEX INCORPORATED AND SHOULD NOT BE USED WITHOUT WRITTEN PERMISSION										