

THIS DRAWING IS UNPUBLISHED. RELEASED FOR PUBLICATION
 © COPYRIGHT - By - ALL RIGHTS RESERVED.

LOC		DIST		REVISIONS			
P	LTR	DESCRIPTION		DATE	DWN	APVD	
-	-	P	P	REVISED PER ECO-11-005030	11MAR11	RK HMR	

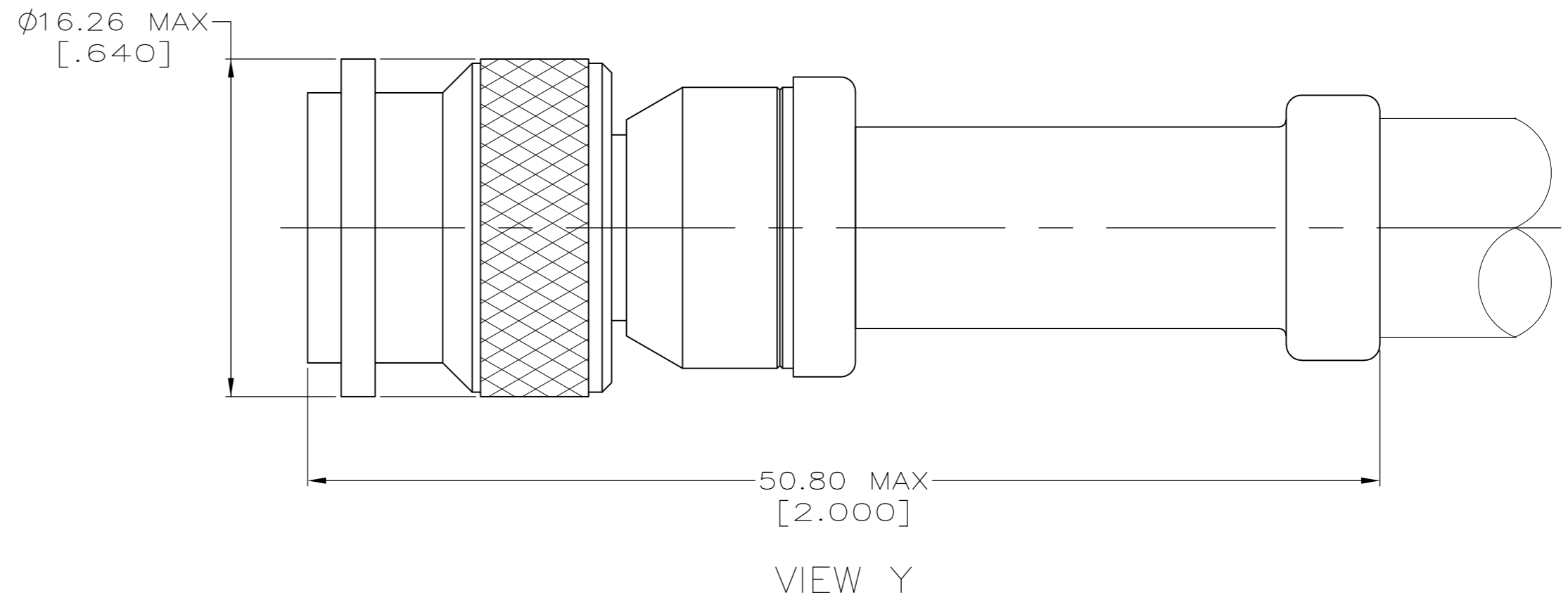

1. SEE I.S. 2299-1

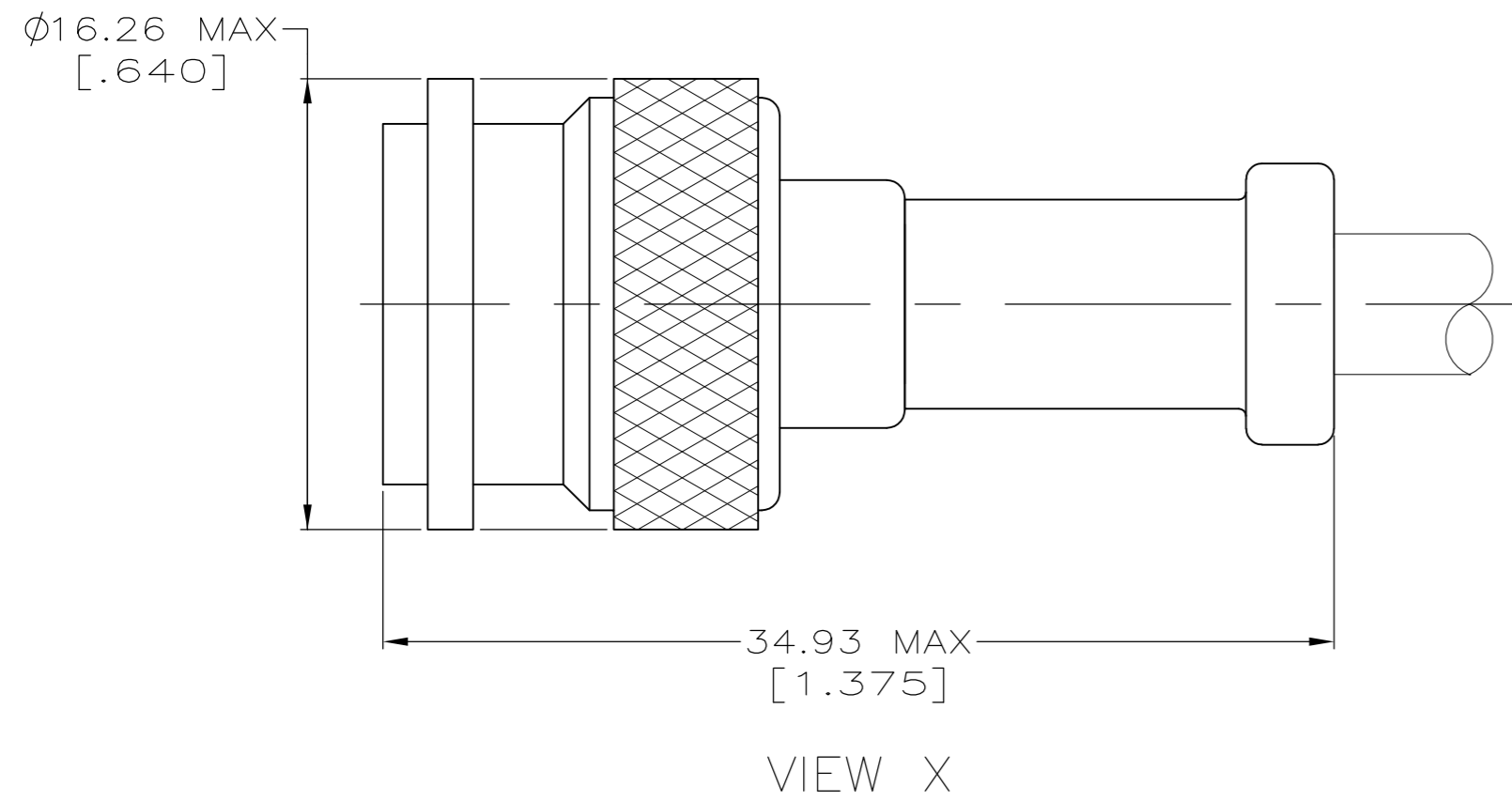
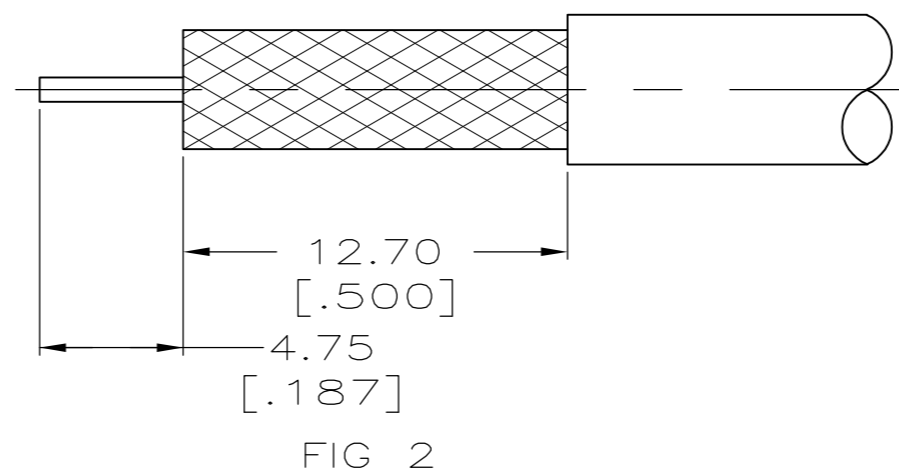
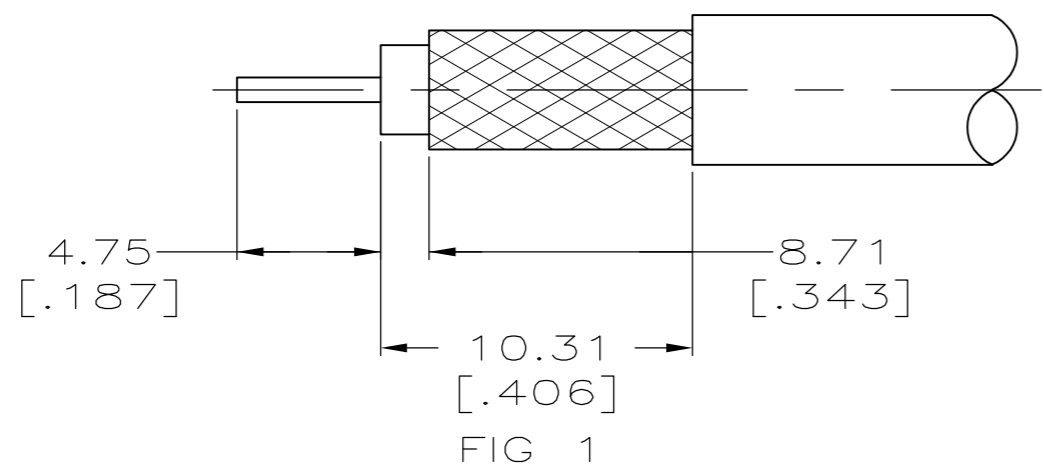

RECOMMENDED STRIP LENGTH

RG-9/U, 9A/U, 9B/U, 214/U	2	220015-1	332022	9-331987-1	225596-2	5-225593-0	Y	522555-8				
RG-8/U, 8A/U, 213/U	2	220015-1	332022	9-331987-0	225596-2	5-225593-0	Y	522555-7				
RG-142/U, 142A/U, 142B/U	1	220045-2	225592-2	9-225560-0	225467-6	225457-2	X	522555-6				
RG-141/U, 141A/U	1	220045-2	225592-1	9-225560-1	225467-6	225457-2	X	522555-5				
RG-58A/U, 58C/U	1	220045-2	225592-1	9-225560-1	225467-2	225457-2	X	522555-2				
FOR USE WITH CABLE	FIGURE	CRIMP TOOL	④	SEAL QTY=1	③	FERRULE QTY=1	②	CONTACT QTY=1	①	PLUG ASSEMBLY QTY=1	VIEW	PART NUMBER

THIS DRAWING IS A CONTROLLED DOCUMENT.

DWN A. FERNANDEZ-DOCK5 31JAN2005	TE Connectivity
CHK J. HAVENER 31JAN2005	
APVD J. LIPPERT 31JAN2005	NAME
PRODUCT SPEC	PLUG, DUAL CRIMP, TNC
APPLICATION SPEC	SIZE A2
WEIGHT	CAGE CODE 00779
CUSTOMER DRAWING	DRAWING NO C=5225555
	RESTRICTED TO
	SCALE 4:1
	SHEET 1 of 1
	REV P