

IEC Appliance Inlet C14 with Fuseholder 1- or 2-pole and Voltage Selector



Order required accessories separately



Approvals and Compliances

Description

- Panel Mount :
Screw-on version from front or rear side, snap-in version from front side
- 3 Functions :
Appliance Inlet Protection class I , Fuseholder with interchangeable fuse drawer for Fuse-links 5x20 mm or 6.3x32 mm 1- or 2-pole , Voltage Selector (series-parallel) Meets the requirements of IEC 60335-1 for appliances in unattended use. This includes the enhanced requirements of glow wire tests acc. to IEC 60695-2-12 and -13.
- Quick connect terminals 4.8 x 0.8 mm

Characteristics

- Available with or without internal partial wired connections
- For added safety "Extra-Safe" fuse drawers are available
- Suitable for use in equipment according to IEC/UL 60950

Other versions on request

- For protection class II

References

Alternative: version with line filter [CE](#)

Weblinks

[pdf datasheet](#), [html-datasheet](#), [General Product Information](#), [Distributor-Stock-Check](#), [Accessories](#), [Detailed request for product](#), [Microsite](#)

Newly available variants corresponding to V-Lock mating cordset. The connector is equipped with a notch intended for use with the latching cordset. The cord latching system prevents against accidental removal of the cordset.

Technical Data

Ratings IEC	10A / 250VAC; 50Hz	appliance inlet/-outlet	C14 acc. to IEC 60320-1, UL 498, CSA C22.2 no. 42 (for cold conditions) pin-temperature 70 °C, 10A, Protection Class I
Ratings UL/CSA	10A / 125VAC; 60Hz	Fuseholder	1 or 2 pole, Shocksafe category PC2 acc. to IEC 60127-6, for fuse-links 5 x 20 or 6.3 x 32 mm
Dielectric Strength	> 3kVAC between L-N > 4kVAC between L/N-PE (1 min/50Hz)	Rated Power Acceptance @ Ta 23 °C	5 x 20: 2.5W (1 pole)/ 2W (2-pole) per pole 6.3 x 32: 3.15W (1 pole)/ 2.5W (2-pole) per pole
Allowable Operation Temperature	-25 °C to 70 °C	Power Acceptance @ Ta > 23°C	Admissible power acceptance at higher ambient temperature see derating curves
IP-Protection	from front side IP 40 acc. to IEC 60529	Voltage Selector	series-parallel, 4, 3 or 2 switch positions or usable as 2-pole change-over switch
Insulation cover	Suitable for appliances with protection class I acc. to IEC 61140		
Terminal	Quick connect terminals 4.8 x 0.8 mm		
Panel Thickness S	Screw: max 8 mm Mounting screw torque max 0.5Nm Snap-in: 1.5/2/2.5 mm		
Material: Housing	Thermoplastic, black, UL 94V-0		



Approvals and Compliances

Detailed information on product approvals, code requirements, usage instructions and detailed test conditions can be looked up in [Details about Approvals](#)

Approvals





The approval mark is used by the testing authorities to certify compliance with the safety requirements placed on electronic products.

Approval Reference Type: KE

Approval Logo	Certificates	Certification Body	Description
	VDE Approvals	VDE	Certificate Number: 40030339
	UL Approvals	UL	UL File Number: E93617
	CSA Approvals	CSA	CSA Certification Record: 38456



Product standards

Product standards that are referenced

Organization	Design	Standard	Description
	Designed according to	IEC 60320-1	Appliance couplers for household and similar general purposes
	Designed according to	IEC 60127-6	Miniature fuses. Part 6. Fuse-holders for miniature fuse-links
	Designed according to	IEC 61058-1	Switches for appliances. Part 1. General requirements
	Designed according to	UL 498	Standard for Attachment Plugs and Receptacles
	Designed according to	CSA C22.2 no. 42	General Use Receptacles, Attachment Plugs, and Similar Wiring Devices







Application standards

Application standards where the product can be used

Organization	Design	Standard	Description
	Designed for applications acc.	IEC/UL 60950	IEC 60950-1 includes the basic requirements for the safety of information technology equipment.
	Designed for applications acc.	IEC 60601-1	Medical electrical equipment - Part 1: General requirements for basic safety and essential performance
	Designed for applications acc.	IEC 60335-1	Safety of electrical appliances for household and similar purposes. Meets the requirements for appliances in unattended use. This includes the enhanced requirements of glow wire tests acc. to IEC 60695-2-12 and -13.

Compliances

The product complies with following Guide Lines

Identification	Details	Initiator	Description
	CE declaration of conformity	SCHURTER AG	The CE marking declares that the product complies with the applicable requirements laid down in the harmonisation of Community legislation on its affixing in accordance with EU Regulation 765/2008.
	RoHS	SCHURTER AG	EU Directive RoHS 2011/65/EU
	China RoHS	SCHURTER AG	The law SJ / T 11363-2006 (China RoHS) has been in force since 1 March 2007. It is similar to the EU directive RoHS.
	REACH	SCHURTER AG	On 1 June 2007, Regulation (EC) No 1907/2006 on the Registration, Evaluation, Authorization and Restriction of Chemicals 1 (abbreviated as "REACH") entered into force.
	MicrositeV-Lock	SCHURTER AG	V-Lock system are based on a matching plug-dose combination. The connector is equipped with a notch intended for use with the latching cordset. The cord latching system prevents against accidental removal of the cordset.
	Medical Equipment	SCHURTER AG	Suitable for use in medical equipment according to IEC/UL 60601-1

Dimensions [mm]

Screw-on mounting



Snap-in mounting

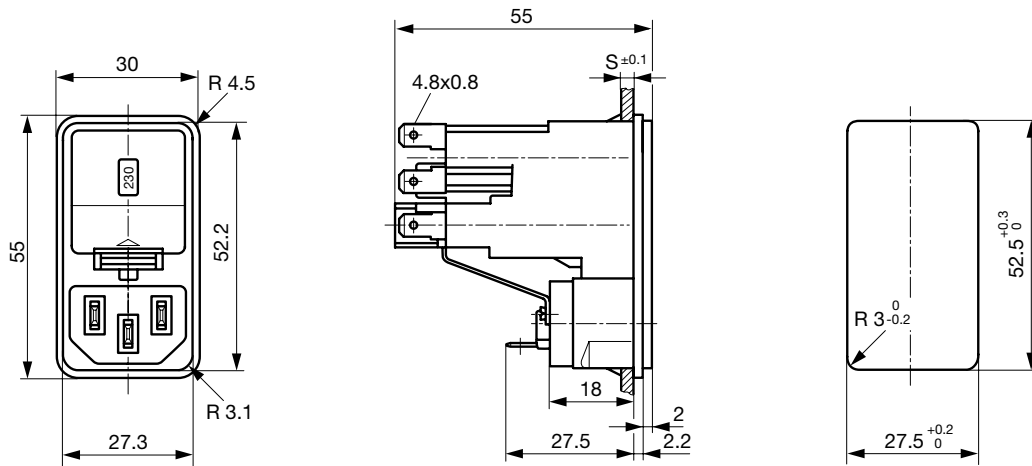

Diagrams

with partial wired internal connections

with partial wired

without internal connections

without internal connections

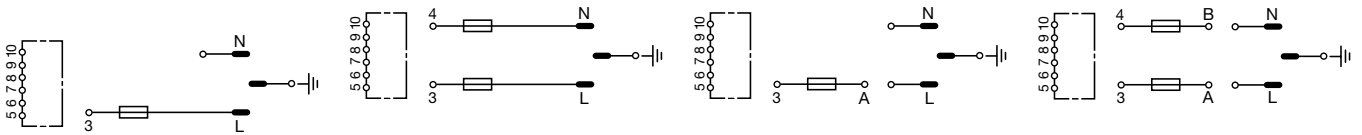

1-pole

2-pole

1-pole

2-pole

Derating Curves

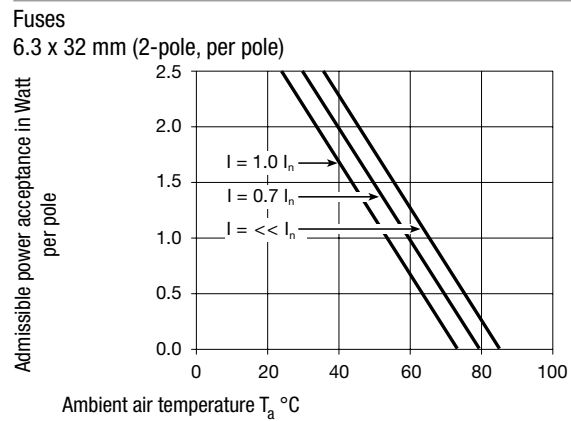
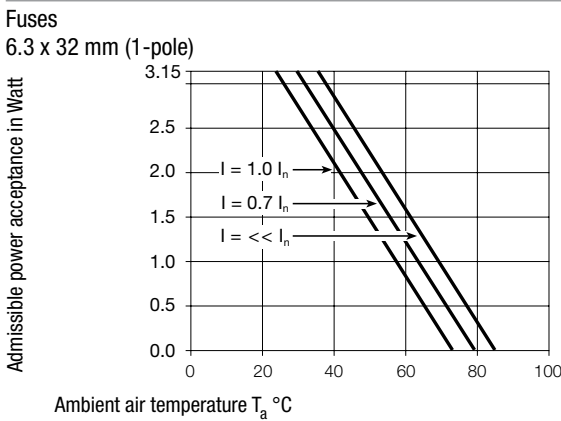
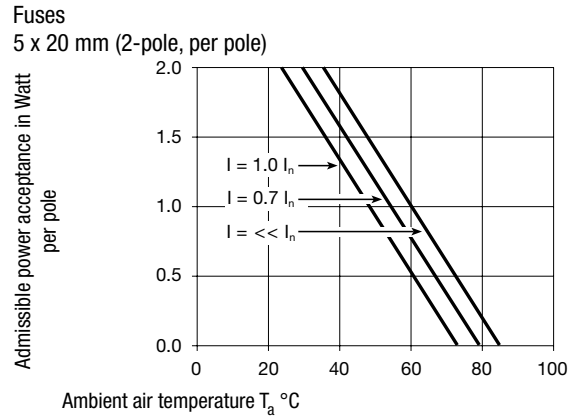
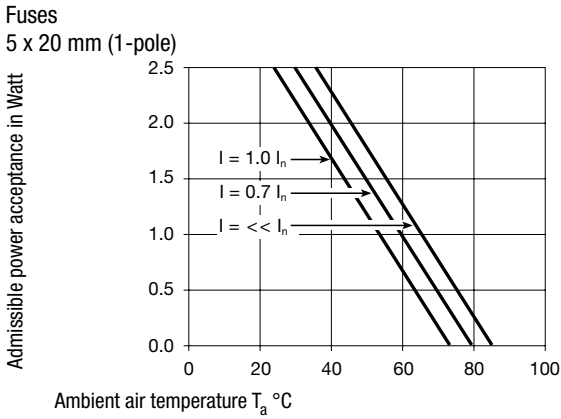

All Variants

Panel mounting	Panel Thickness s [mm]	Fuseholder	Internally wired	V-Lock	Order Number
Snap-in	1.5	1-pole	unwired		KE15.1100.105
Snap-in	1.5	1-pole	partially wired		KE16.5100.105
Snap-in	2	1-pole	partially wired		KE16.5100.107
Snap-in	2.5	1-pole	partially wired		KE16.5100.109
Snap-in	1.5	2-pole	unwired		KE10.2100.105
Snap-in	2	2-pole	unwired		KE10.2100.107
Snap-in	2.5	2-pole	unwired		KE10.2100.109
Snap-in	1.5	2-pole	partially wired		KE10.6100.105
Snap-in	2	2-pole	partially wired		KE10.6100.107
Snap-in	2.5	2-pole	partially wired		KE10.6100.109
Screw	-	1 or 2 pole	prewired or unwired		KE20.2100.151
Screw	-	1-pole	unwired		KE15.1100.151
Screw	-	1-pole	partially wired		KE16.5100.151
Screw	-	2-pole	unwired		KE10.2100.151
Screw	-	2-pole	partially wired		KE10.6100.151

Most Popular:

Availability for all products can be searched real-time: <https://www.schurter.com/en/Stock-Check/Stock-Check-SCHURTER>

Packaging unit 20 Pcs

Required Accessory

Description



Fusedrawer 1
 Fusedrawer for Fuse Links 5x20 mm resp. 6.3x32 mm

5 x 20, 2-pole	4305.0001
5 x 20, 1-pole	4305.0006
6.3 x 32, 2-pole	4305.0011
6.3 x 32, 1-pole	4305.0016
...	



Jumper Wire 1
 Connection with Stranded Cable

Type A, 70 mm	0881.0074
Type A, 100 mm	0881.0075
Type B, 70 mm	0881.0076
Type B, 100 mm	0881.0077



Voltage Selectors Insert 1
 Voltage Selector Insert to KE, CE, KG, CG

3 or 4 switch positions	4305.0048.00
1, 3 or 4 switch positions, 100, 120, 220, 240	4305.0048.01
3, 3 or 4 switch positions, 130, 110, 240, 220	4305.0048.02
2, 2 switch positions, 110, 220	4305.0048.03
...	

Accessories



Assorted Covers
 Rear Cover

	0859.0076
--	-----------



Cord retaining kits
 Cord retaining strain relief

Flat head, A	4700.0001
--------------	-----------

Mating Outlets/Connectors

Category / Description



Appliance Outlet Overview complete

IEC Appliance Outlet F, Screw-on Mounting, Front Side, Solder Terminal	4787
IEC Appliance Outlet F, Snap-in Mounting, Front Side, Solder or Quick-connect Terminal	4788
IEC Appliance Outlet F or H, Screw-on Mounting, Front Side, Solder, PCB or Quick-connect Terminal	5091

[Appliance Outlet further types to KE](#)

[Connector Overview complete](#)



4782 Mounting: Power Cord, 3 x 1 mm ² / 3 x 18 AWG, Cable, Connector: IEC C13	4782
4022 Mounting: Power Supply Cord, 3 x 1.5 mm ² , Screw clamps, Connector: IEC C13	4022
4785 Mounting: Power Cord, 3 x 1 mm ² / 3 x 18 AWG, Cable, Connector: IEC C13	4785
4300-06 Mounting: Power Cord, 3 x 1 mm ² / 3 x 18 AWG, Cable, Connector: IEC C13	4300-06
4012 Mounting: Power Supply Cord, 3 x 1.5 mm ² , Screw clamps, Connector: IEC C13	4012
Connector further types to KE	...

Mating Outlets/Connectors shuttered

[Power Cord Overview complete](#)



VAC13KS, Overview, diverse Connector IEC C13, cord end:	VAC13KS
Power cord with IEC connector C17, V-Lock, straight	VAC17KS
Power Cord further types to KE	