

DESCRIPTION: M12 MALE - CABLE MOUNT - SOLDER CUP - 5 POS. - HIGH VIBRATION

NOTE:

MATERIAL
 HOUSING: PA66 UL94V-0, BLACK
 CONTACT: BRASS
 NUT: BRASS
 FINISH
 CONTACT: 10µ GOLD
 OVER 50µ NICKEL
 NUT: NICKEL PLATED
 60µ TO 100µ OVER ALL

ELECTRICAL
 RATED CURRENT: 3A
 RATED VOLTAGE: 60V
 INSULATION RESISTANCE: 100 mΩhms MIN.
 CONTACT RESISTANCE: 10 MΩhms MAX.
 WATER PROOF: IP67

ENVIRONMENT
 OPERATION TEMPERATURE: -40°C TO +105°C
 WIRE GAUGE: 24-28 AWG

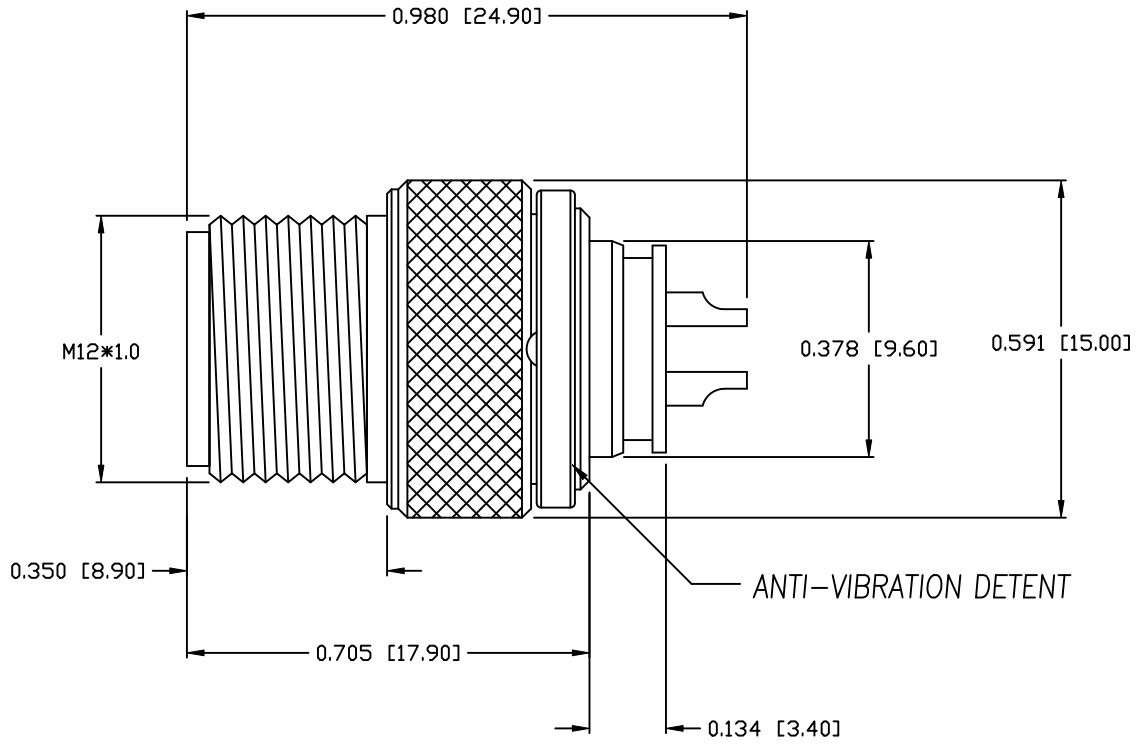
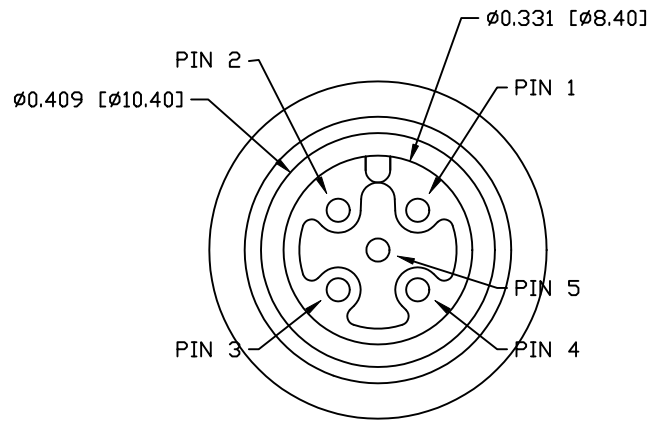

RoHS COMPLIANT

DO NOT SCALE FROM DRAWING



THESE DRAWINGS AND SPECIFICATIONS ARE THE PROPERTY OF NorComp AND SHALL NOT BE REPRODUCED, COPIED OR USED AS THE BASIS FOR THE MANUFACTURE OR SALE OF APPARATUS WITHOUT WRITTEN PERMISSION.

DRAWN: M. SIGMON
 DATE: 08-04-16
 CHECKED:
 DATE:

NorComp

SCALE: N.T.S.
 SHEET 1 OF 1
 REV 1
 DWG NO. 858VA05-103RLU4