

INTERCONNECTS

SERIES 850 & 851 • .050" GRID HORIZONTAL SURFACE MOUNT Z-BEND HEADERS & SOCKETS • SINGLE ROW STRIPS

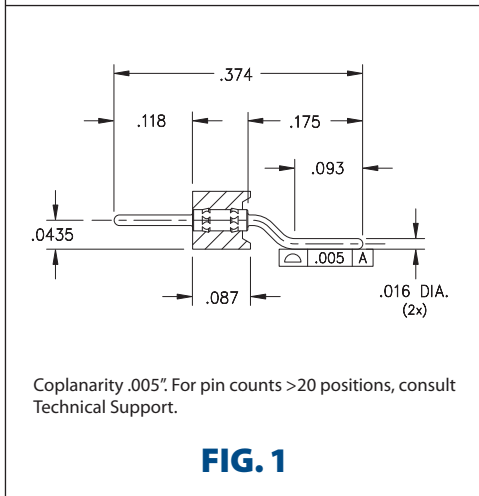
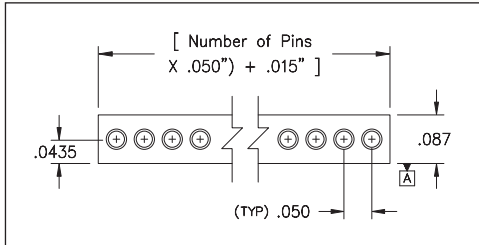

FIG. 1

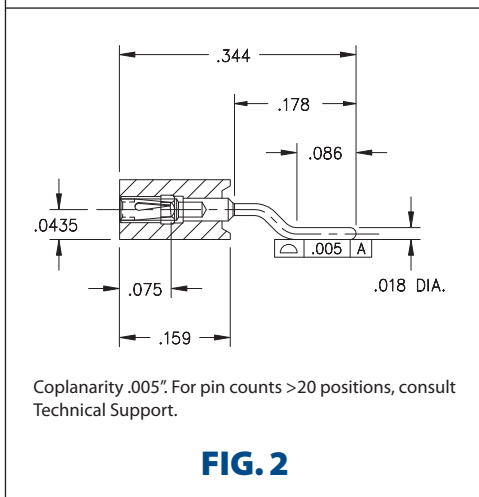
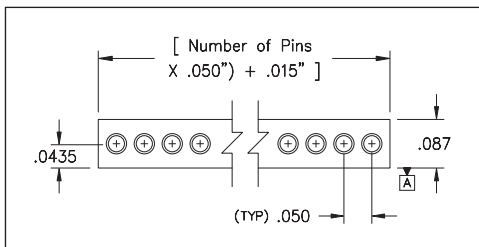
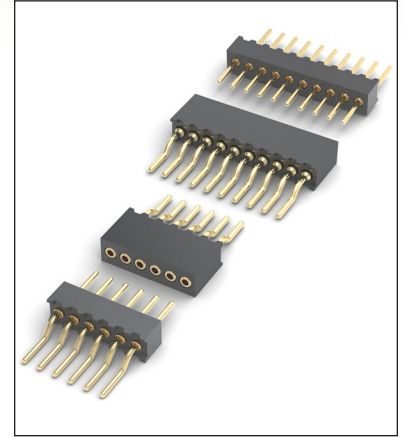

FIG. 2

- Series 850 horizontal surface mount headers have .016" dia. pluggable pins and Z-bend tails for SMT soldering to the P.C.B. (MM #4006-1). See page 208 for details
- Series 851 horizontal Surface Mount Z-Bend sockets uses MM #4890-1 receptacles that accept pin diameters from .015"-.020". See page 160 for details
- Receptacles use Hi-Rel, 3-finger BeCu #11 contact rated at 3 amps. See page 251 for details
- Insulators are high temperature thermoplastic, suitable for all soldering operations



ORDERING INFORMATION



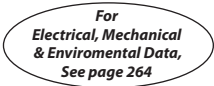



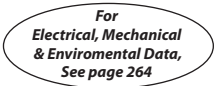

FIG. 1	Series 850...001 Single Row Surface Mount Z-Bend Header					
	850-10-0-40-001000					
	Specify number of pins		02-20			
  						
SPECIFY PLATING CODE XX=		10	◆			
Pin Plating 		10 μ" Au				

FIG. 2	Series 851...001 Single Row Surface Mount Z-Bend Socket					
	851-XX-0-40-001000					
	Specify number of pins		02-20			
  						
SPECIFY PLATING CODE XX=		11	◆	13	◆	
Sleeve (Pin) 		10 μ" Au		10 μ" Au		
Contact (Clip) 		10 μ" Au		30 μ" Au		