

Contact insert - VC-D3-BU50-PE - 1855076

Please be informed that the data shown in this PDF Document is generated from our Online Catalog. Please find the complete data in the user's documentation. Our General Terms of Use for Downloads are valid (<http://phoenixcontact.com/download>)

Female contact carrier, for turned crimp contacts, type VC 3, 50-pos. + PE



Why buy this product

- Positions 15, 30, 50, and 65 are available, in accordance with housing sizes VC 1 - VC 4.
- Contact types meet the requirements of IEC 60352/DIN EN 60352
- Contact carriers have two further capacitive PE contacts
- Pin and socket contacts can be used on both the plug and device sides
- The connection data of 250 V/10 A corresponds to that of the HEAVYCON DD series

Key Commercial Data

Packing unit	10 STK
GTIN	 4 017918 159368
GTIN	4017918159368

Technical data

Electrical characteristics

Note	Connectors may only be connected/disconnected when under no load.
Rated voltage	250 V
Rated voltage (III/3)	250 V
Rated current	10 A
	10 A
Rated surge voltage	4 kV
Connection profile	50+PE

Ambient conditions

Ambient temperature (operation)	-40 °C ... 125 °C
---------------------------------	-------------------

Mechanical characteristics

Conductor cross section	0.14 mm ² ... 1.5 mm ² (flexible)
-------------------------	---

Contact insert - VC-D3-BU50-PE - 1855076

Technical data

Mechanical characteristics

Connection cross section AWG	22 ... 16
Stripping length of the individual wire	8 mm
Contact diameter	1.6 mm
Conductor cross section flexible max.	1.5 mm ²
Insertion/withdrawal cycles	>= 500

General

Size	VC3
Series	VC-D
Connection method	Crimp connection
Contact type	turned
Flammability rating according to UL 94	V0
Degree of pollution	2

Material data

Contact carrier material	PA-GF
--------------------------	-------

Standards and Regulations

Connection in acc. with standard	CUL
Flammability rating according to UL 94	V0

Environmental Product Compliance

REACH SVHC	Lead 7439-92-1
China RoHS	Environmentally Friendly Use Period = 50
	For details about hazardous substances go to tab "Downloads", Category "Manufacturer's declaration"

Drawings

Dimensional drawing

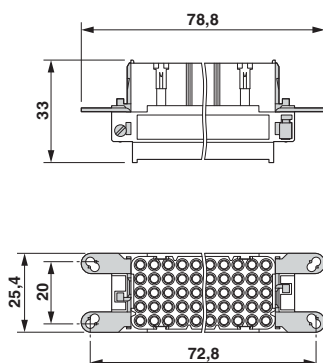

Dimensional drawing

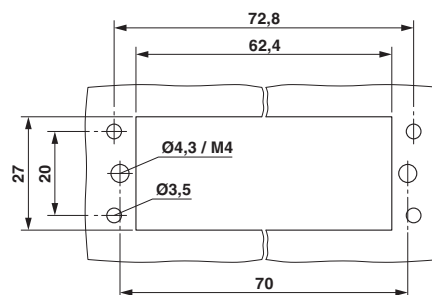

Mounting cutout

Contact insert

Contact insert - VC-D3-BU50-PE - 1855076

Approvals

Approvals

Approvals

UL Recognized / cUL Recognized / EAC / cULus Recognized

Ex Approvals

Approval details

UL Recognized		http://database.ul.com/cgi-bin/XYV/template/LISEXT/1FRAME/index.htm	FILE E 118976
Nominal voltage UN		250 V	
Nominal current IN		4 A	

cUL Recognized		http://database.ul.com/cgi-bin/XYV/template/LISEXT/1FRAME/index.htm	FILE E 118976
Nominal voltage UN		250 V	
Nominal current IN		4 A	

EAC			B.01742
-----	---	--	---------

cULus Recognized		http://database.ul.com/cgi-bin/XYV/template/LISEXT/1FRAME/index.htm	
------------------	---	---	--

Phoenix Contact 2018 © - all rights reserved
<http://www.phoenixcontact.com>

PHOENIX CONTACT GmbH & Co. KG
Flachsmarktstr. 8
32825 Blomberg
Germany
Tel. +49 5235 300
Fax +49 5235 3 41200
<http://www.phoenixcontact.com>